

How to Combat the Helium Shortage: Making the Switch from Helium to Hydrogen or Nitrogen

Mark Sinnott
Application Engineer
24 May 2022

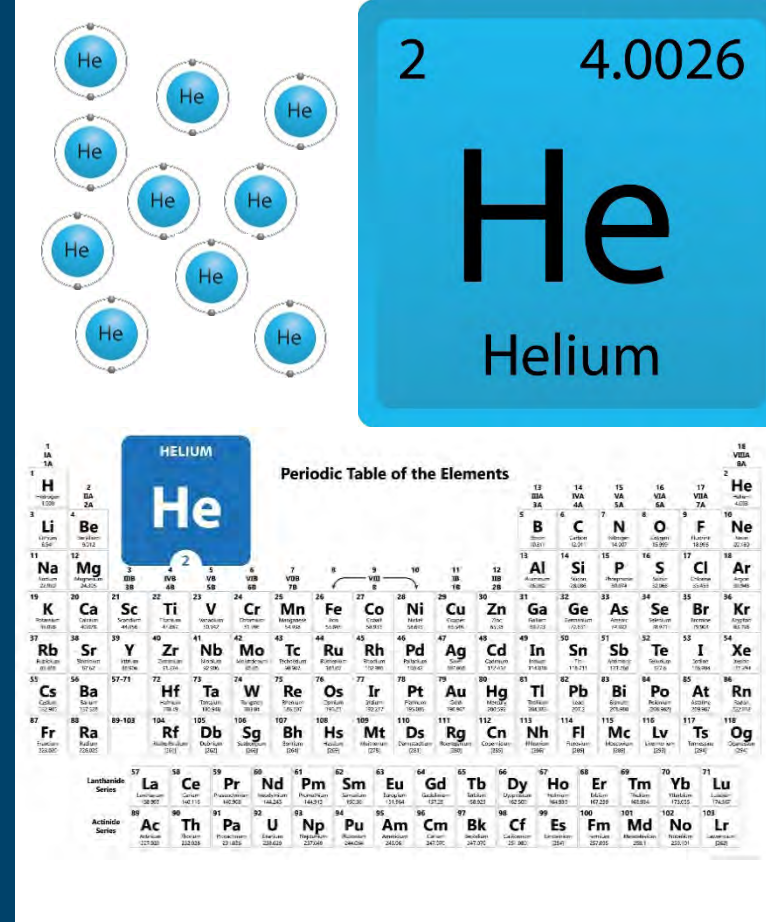

The image shows a large blue card for Helium (He) with the atomic number 2 and atomic weight 4.0026. To the left, several small circles represent Helium atoms. Below the card is a standard periodic table of elements with Helium highlighted in a blue box.



Market Situation

The world of He supply is not reliable and becoming more scarce, prices are increasing, and customers are seeking alternative carrier gases.



Researchers have a need to find suitable alternatives to either eliminate or reduce He consumption.

Industries That Use Helium



Healthcare

Magnetic Resonance Imaging (MRI)

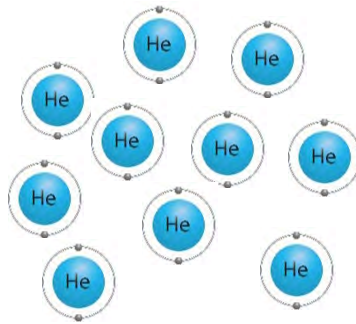

Research

Nuclear Magnetic Resonance spectroscopy (NMR)

Gas chromatography

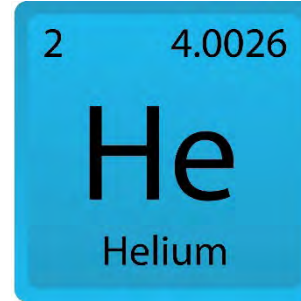

Boiling point
-269 °C/4.2 K

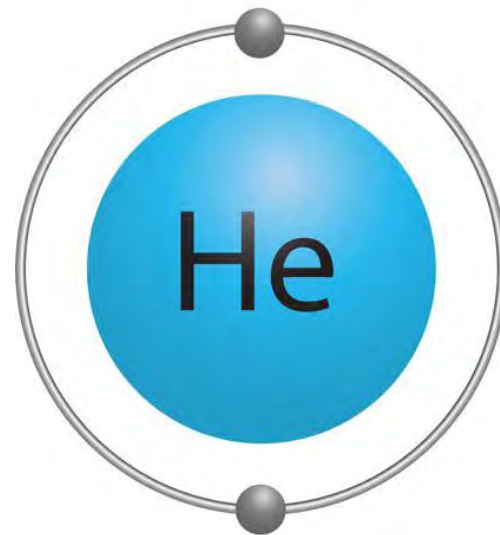

Webinar Outline

- Use of Gas Saver
- Hydrogen safety
- Carrier gas decision tree
 - Decision making guide to fit your carrier gas requirements
- Migrating existing helium GC methods to H₂ or N₂
 - Best practices to obtain the same results and minimize method revalidation
- Helium conservation
 - Smarter helium use with new hardware/software tools
 - No need to revalidate existing GC methods
- Cautions about making the switch to Hydrogen for MSD systems

Have You Ever Noticed the Gas Saver Section of the Inlet Method Editor?

The screenshot displays the 'GC EditParameters' window. At the top, a 'Back Inlet Flow Path' diagram shows components: Back SS Inlet (10.3 psi [10.3 psi]), Column #1 (60 °C [60 °C]), Backflush Gas (4 psi [4 psi]), Column #2 (60 °C [60 °C]), and MSD. A graph on the right shows 'Oven: °C*' (red line) and 'Thermal Aux 2: °C' (black line) with a temperature profile. The main area is divided into two sections:

- Inlet Mode (Split 100 : 1)**: A dropdown menu is set to 'Split'. The 'Split Ratio' is '100 : 1' and the 'Split Flow' is '113 mL/min'.
- Gas Saver**: A checkbox is checked 'On'. The flow rate is '20 mL/min' and the duration is 'After: 2 min'.

Buttons for 'Apply', 'OK', 'Cancel', and 'Help' are located at the bottom of the window.

Why Would I Want to Use Gas Saver?

The screenshot displays the 'GC Edit Parameters' interface. At the top, a 'Back Inlet Flow Path' diagram shows the flow from the 'Back SS Inlet' (10.3 psi, 280 °C) through 'Column #1' (60 °C, 1.1 mL/min) and 'Backflush Gas' (4 psi) to 'Column #2' (60 °C, 1.3 mL/min) and finally to the 'MSD'. A temperature graph on the right shows a baseline at 50 °C with a slight rise to 100 °C. Below the diagram, the 'Split-Splitless Inlet' section is visible, with a 'Select Liner...' dropdown and a 'Liner: Agilent 5190-2295: 870 µL (Universal, low pressure drop, ultra...' description. A large blue-bordered box highlights the 'Total Flow' section, showing '24.13 mL/min' and '117.13 mL/min'. The 'Inlet Mode (Split 100 - 1)' dropdown is set to 'Split', with a 'Split Ratio' of '100 : 1' and a 'Split Flow' of '113 mL/min'. At the bottom, a blue-bordered box highlights the 'Gas Saver' settings, which are checked and set to 'On' at '20 mL/min' for '2 min' after injection.

- When enabled, GC automatically runs Gas Saver
 - Beneficial when using split mode
- Gas Saver mode turns **on** after injection
 - Turns **off** during the prep run and injection duration
- Lowers the use of carrier gas to save helium (or other carrier gas) and cuts costs
- Ensures it is not actually using more gas (low split ratio)
- **Suggested parameters**
 - Flow – No lower than 15 mL/min
Recommended: ~20 mL/min
 - Time – ~2 to 5 minutes

Carrier Gas Decision Tree

Migrating GC methods to nitrogen and hydrogen

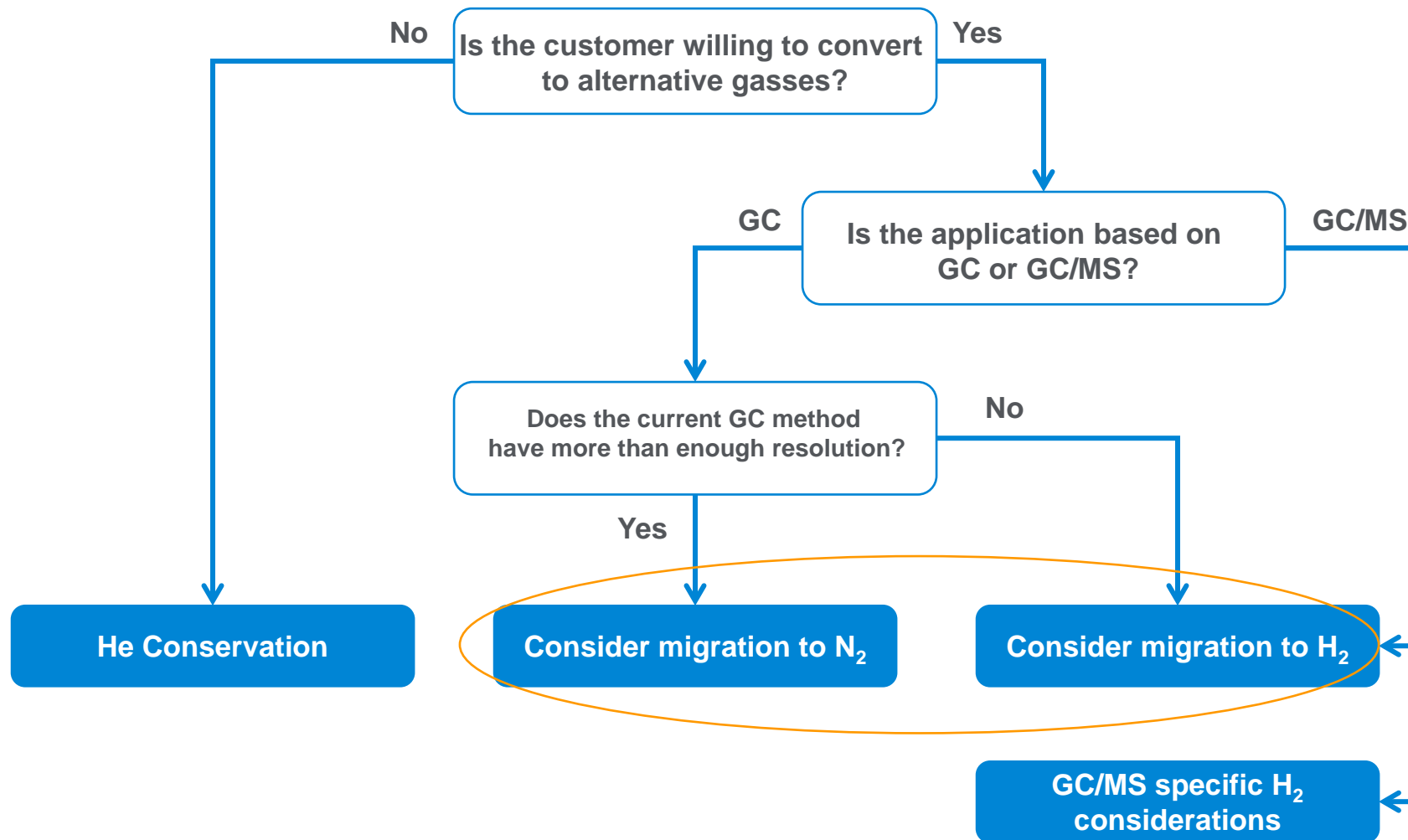

Safety Considerations for Hydrogen Migration

Both GC and GC/MS offer H₂ enabled features:

Safety shutdown

- When gas pressure setpoints are not met, the valve and heater are shut off to prevent an explosion

Flow limiting frit

- If valve fails in open position, inlet frit limits the flow

Oven ON/OFF sequence

- Fan purges the oven before turning on heater to remove any collected H₂

Explosion “ready”

- GC and MS designed to contain parts in case of explosion (for example, spring in GC door)

H₂ sensor available

- <https://www.agilent.com/en/products/gas-chromatography/gc-systems/7890b-gc-system/h2sensor>

Read the hydrogen safety guide:

<https://www.agilent.com/cs/library/usermanuals/public/Hydrogen.pdf>

Considerations for Hydrogen Gas Sources

H₂ generator – preferred

- Very clean H₂, >99.9999% available
- Consistent purity
- Built-in safety features
- Make sure to buy a good generator with a low spec for water and oxygen
- Parker's H-MD are used at Agilent sites
- Use Gas Clean filter

H₂ cylinder

- Use Gas Clean filter
- Possible to add safety device
 - <https://www.agilent.com/en/products/gas-chromatography/gc-systems/7890b-gc-system/h2sensor>



Considerations for Hydrogen Gas Plumbing

Tubing

- Use chromatographic quality stainless steel tubing (recommended)
- Do not use old tubing (H₂ is known as scrubbing agent)
- Especially don't use old copper tubing (brittleness is a safety concern)

Venting

- Connect split vent and septum purge vent to exhaust

Leak checking

- Recommend G6696A / G6693A leak detector (pub # 5994-4202EN)
- Is a Leak Causing Your Inaccurate Results? Agilent CrossLab CS Electronic Leak Detector

H₂ sensor available

- <https://www.agilent.com/en/products/gas-chromatography/gc-systems/7890b-gc-system/h2sensor>



Use N₂ As Carrier Gas

Many HPI methods suited to nitrogen

- Readily available and less expensive gas
- No safety concerns
- Suitable for simple routine analysis (with sufficient resolution)
- More inert than H₂, especially with PLOT/micropacked columns
 - Some compounds catalytically reduced in H₂
- 2-D GC ideally suited to nitrogen
 - Resolution issues solved using two different columns



Potential issues

- Reduced chromatographic resolution at higher flows
- Not suitable for GC/MSD and certain GC detector applications

Van Deemter

Why nitrogen gets a bad reputation for capillary GC

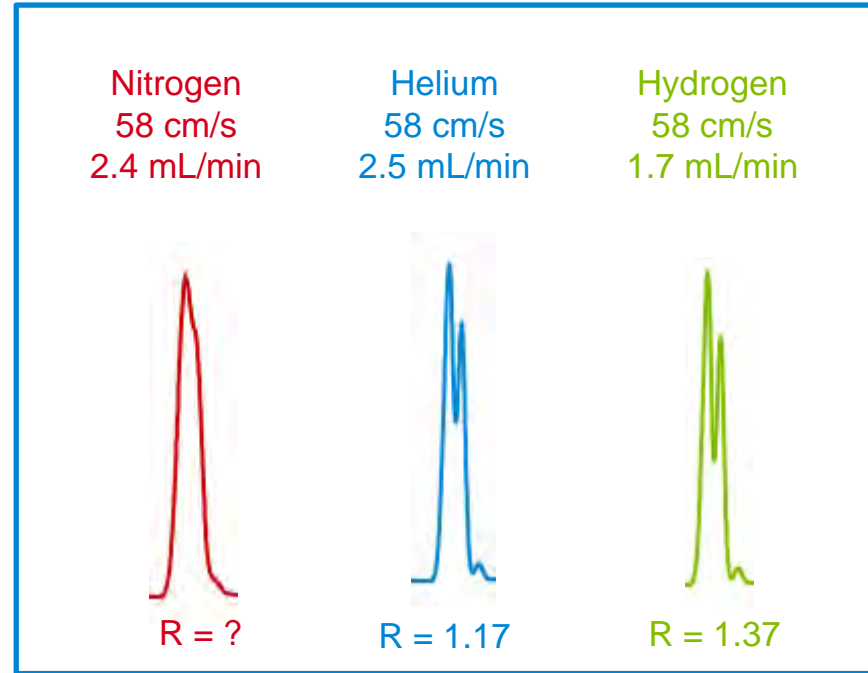
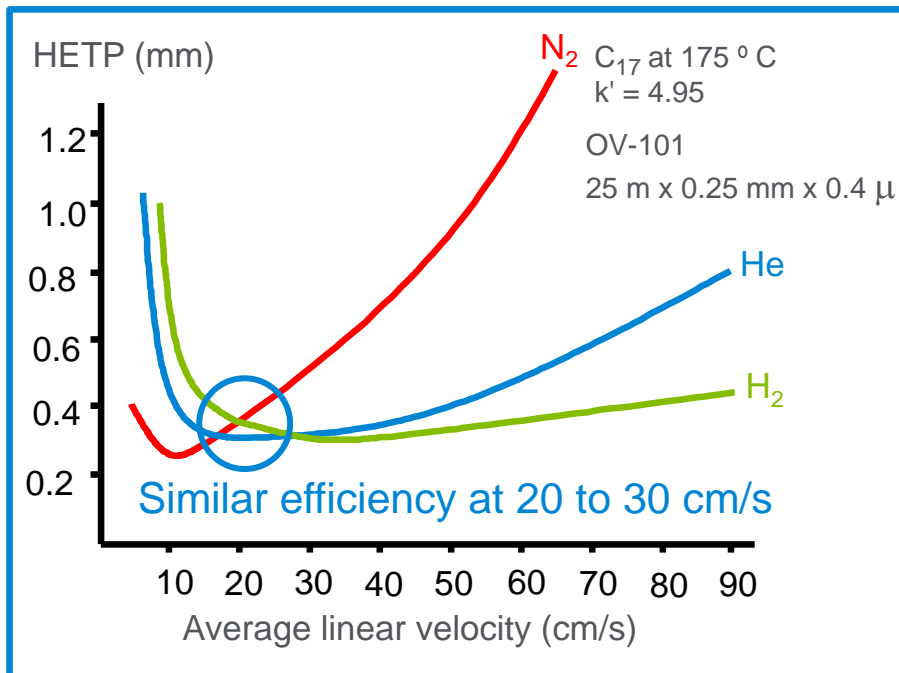

- N_2 actually provides the best efficiency, but at a slower speed
- Most helium methods have too much resolution
 - Lower N_2 efficiency at higher flows can still provide “good enough” resolution
- Most GC methods now use constant flow
 - N_2 efficiency losses with temperature programming are not as severe

Helium Carrier Gas Alternatives

Important theoretical considerations relating to peak efficiency

Sharp, narrow peaks in a chromatogram is an indication of a high efficiency GC column.

- Remember that efficiency is represented mathematically by the symbol " N " called *Theoretical Plates*, and that the larger N is, the better the resolving power of the column (i.e., higher resolution).
- Resolution is described mathematically by the symbol R_s and its numeric value tells how well two adjacent peaks are separated from each other.

$$R_s = \frac{\sqrt{N}}{4} \left(\frac{k}{k+1} \right) \left(\frac{\alpha-1}{\alpha} \right)$$

A resolution value of 1.5 tells us that two peaks are baseline separated. The greater (higher) the R_s value, the more separation that has been achieved.

Calculating efficiency

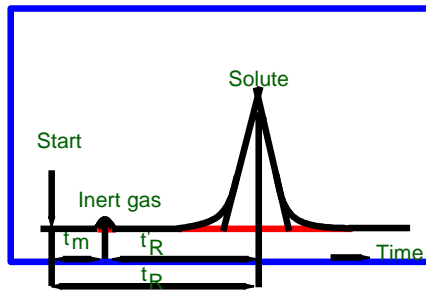

We would like to know the actual time the component spends in the stationary phase.

$$t'_R = t_R - t_m \quad n = \frac{t'_R}{\left(\frac{t'_R}{W_h} \right)^2}$$

t'_R = corrected retention time.

n = effective theoretical plates.

Let's relate " n " to the length of the column.

$$\text{Plates per meter (N)} = \frac{n}{L} \quad \text{or}$$

$$\text{Height equivalent to a theoretical plate (HETP)} = \frac{L}{n}$$

Thus, the more efficient the column, the bigger the " N " the smaller the "HETP".

Efficiency and carrier gas linear velocity

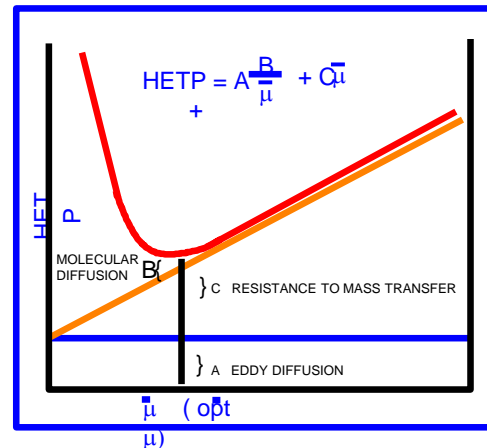

Efficiency is a function of the carrier gas linear velocity or flow rate.

The minimum of the curve represents the smallest HETP (or largest plates per meter) and thus the best efficiency. "A" term is not present for capillary columns.

- Plot of HETP versus linear velocity is known as the **Van Deemter** plot.
- The linear velocity value at the minimum of the curve is the optimum value for achieving the best efficiency.

Helium Carrier Gas Alternatives

Let's make this easy

Sharp, narrow peaks in a chromatogram is an indication of a high efficiency GC column.

- Remember that efficiency is represented mathematically by the symbol "N" called *Theoretical Plates*, and that the larger N is, the better the resolving power of the column (i.e., higher resolution).
- Resolution** is described mathematically by the symbol R_s and its numeric value tells how well two adjacent peaks are separated from each other.

$$R_s = \frac{\sqrt{N}}{4} \left(\frac{k}{k+1} \right) \left(\frac{\alpha-1}{\alpha} \right)$$

A resolution value of 1.5 tells us that two peaks are baseline separated. The greater (higher) the R_s value, the more separation that has been achieved.

Calculating efficiency

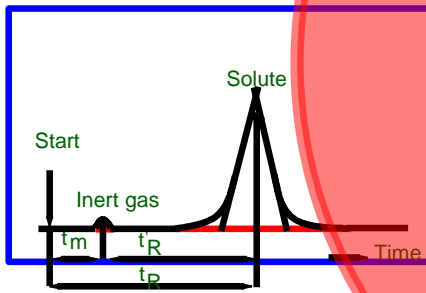

Let's relate "n" to the length of the column.

Plates per meter (N) = $\frac{n}{L}$ or

Height equivalent to a theoretical plate (HETP) = $\frac{L}{n}$

Thus, the more efficient the column, the bigger the "N" the smaller the "HETP".

We would like to know the actual time the component spends in the stationary phase.

$$t'_R = t_R - t_m \quad n = \frac{(t'_R)^2}{5.545 \cdot W_b^2}$$

t'_R = corrected retention time.

n = effective theoretical plates.

Efficiency and carrier gas linear velocity

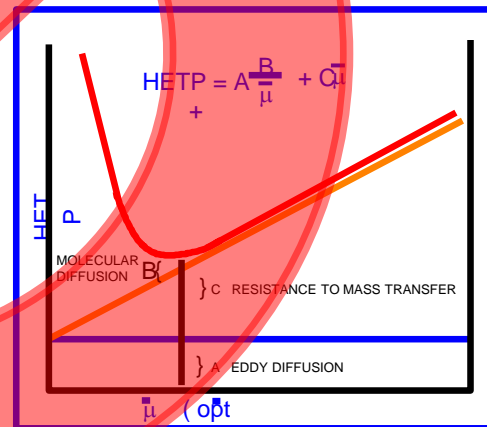

Efficiency is a function of the carrier gas linear velocity or flow rate.

The minimum of the curve represents the smallest HETP (or largest plates per meter) and thus the best efficiency. "A" term is not present for capillary columns.

- Plot of HETP versus linear velocity is known as the Van Deemter plot.
- The linear velocity value at the minimum of the curve is the optimum value for achieving the best efficiency.

Helium Carrier Gas Alternatives

Let's make this easy

- Goal: Change carrier gas while keeping other method conditions the same
 - Use the same column
 - Use the same oven program
 - Adjust column flow or holdup time to:
 - Maintain same peak elution order
 - Maintain same peak retention times (or as close as possible)
- Easier method revalidation using this approach
 - Minimal changes to timed integration events
 - Minimal changes to peak identification table
- For N₂, test resolution of key components
 - Adjust GC conditions (temperature, flow) if needed

Many Helium GC Methods Have Excess Resolution

EN14103 – GC analysis of FAME content in biodiesel

HP-INNOWax, 30 m x 0.25 mm id x 0.25 μ m

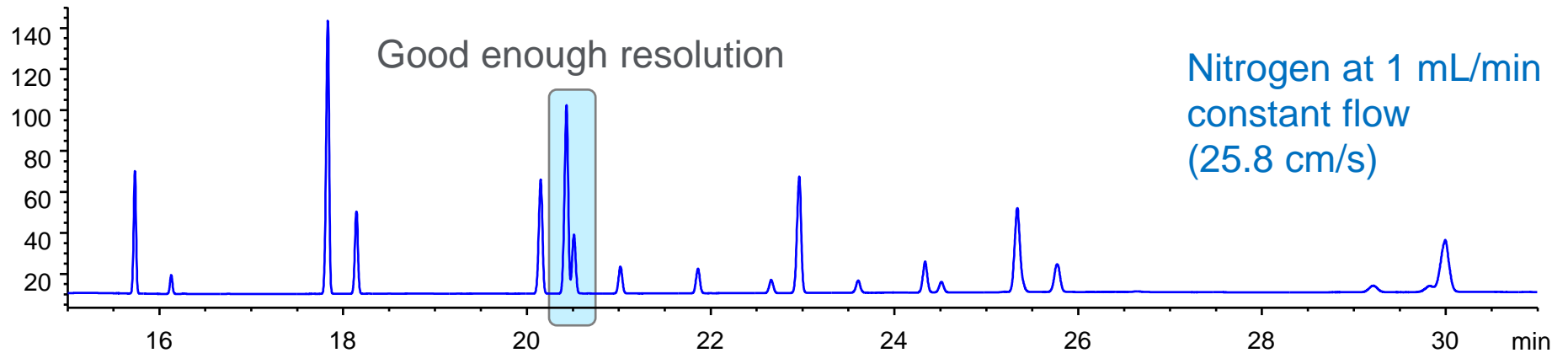
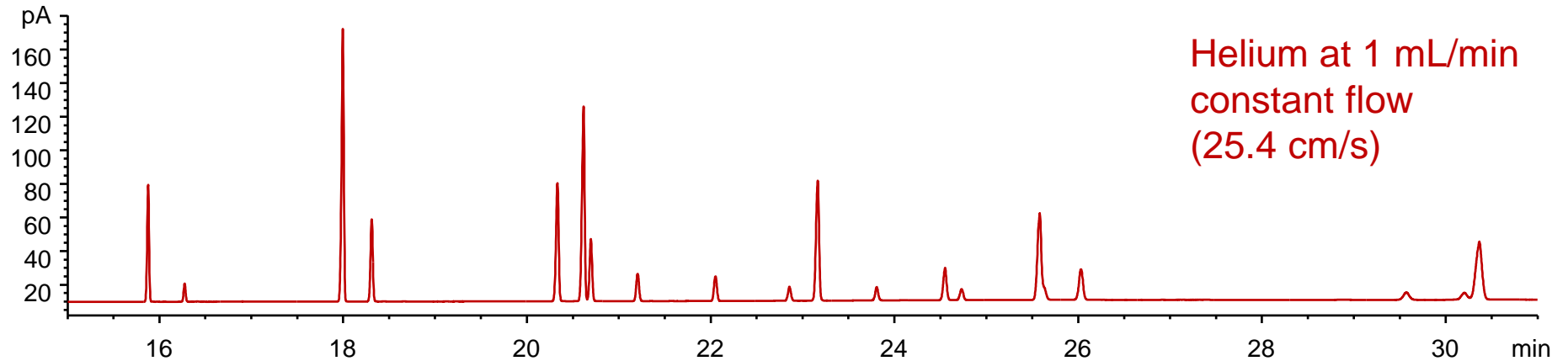

Configure Inlet for Carrier Gas in ChemStation/OpenLab

The screenshot displays the 'Setup Method' dialog box for an Agilent 7890A. At the top, there is a graph showing 'Oven: °C*' (red line), 'Column 1 He: psi' (black line), and 'Column 1 He: mL/min' (green dashed line) over a 30-minute run time. Below the graph is a toolbar with icons for ALS, Valves, Inlets, Columns, Oven, Detectors, Events, Signals, Configuration, Counters, and Readiness. The 'Configuration' tab is active, showing settings for 'Miscellaneous', 'Columns', 'Modules', and 'ALS'. The 'ALS' section includes 'Front Inlet' (SS Inlet: He), 'Back Inlet' (COC Inlet: He), 'Front Detector' (FID, Makeup: N2), and 'Back Detector' (FID, Makeup: N2). The 'Aux EPC 1,2,3' section includes 'Aux EPC 1' (N2), 'Aux EPC 2' (H2), and 'Aux EPC 3' (He). The 'PCM A' section includes 'PCM A-1' (He) and 'PCM A-2' (He), with a 'Channel B Control Mode' dropdown set to 'Forward Pressure'. At the bottom, there are 'OK', 'Apply', 'Cancel', and 'Help' buttons.

Select H₂ or N₂

How Do I Build a New Method for Use with H₂ or N₂ Carrier?



Method Translation Calculator

Another useful tool for carrier gas calculations

Agilent Technologies Method Translator

Last file imported:

Speed gain: 1.0000

Translate

Best Efficiency

Original Method Parameters

Gas: He

Calculated Method Parameters

Gas: N2

Length (m): 30 m

Inner Diameter (µm): 320 µm

Film Thickness (µm): 0.25 µm

Phase Ratio: 320

Inlet Pressure (gauge): 7.0569 psi

Outlet Flow (mL/min): 1.3158 mL/min

Average Velocity (cm/s): 24.342 cm/sec

Outlet Pressure (abs): 14.696 psi

Holdup Time: 2.0541 min

Outlet Velocity (cm/s): 30.468 cm/sec

Calculated Outlet Flow: 1.2921 mL/min

Calculated Average Velocity: 24.342 cm/sec

Calculated Outlet Velocity: 29.919 cm/sec

Temperature Profile:

#	Ramp Rate (°C/min)	Final Temp (°C)	Final Time (min)
Init		60	1
1	5.0000	200	1

Total Run Time: 30.00 min

Original Column Capacity: 2.48

Translated Column Capacity: 2.48

- Flexible tool helps convert existing helium methods to alternative carrier
- Built into the new OpenLab CDS software
- Can also run as Windows 7 program
- Download from the Agilent Helium Update page:
<https://community.agilent.com/technical/consumables/w/wiki/6933/software-supported-method-development---the-scanview-program>



Same Column, Hydrogen Carrier Gas

Speed gain

New pressure/flow/velocity



New temperature program

Speed gain: 1.4251

Translate

Best Efficiency

Last file imported:

Original Method Parameters		Calculated Method Parameters	
Gas	He	Gas	H2
Length (m)	30 m	30 m	
Inner Diameter (µm)	320 µm	320 µm	
Film Thickness (µm)	0.25 µm	0.25 µm	
Phase Ratio	319.25	319.25	
Inlet Pressure (gauge)	12.786 psi	8.1484 psi	
Outlet Flow (mL/min)	2.0887 mL/min	2.6109 mL/min	
Average Velocity (cm/s)	38.713 cm/sec	55.168 cm/sec	
Outlet Pressure (abs)	14.696 psi	14.696 psi	
Holdup Time	1.2916 min	0.90632 min	
Outlet Velocity (cm/s)	57.077	71.346	

#	Ramp Rate (°C/min)	Final Temp (°C)	Final Time (min)
Init		120	1.17
1	25.0000	160	0.00
2	10.0000	260	0.00

Total Run Time: 19.44 min

#	Ramp Rate (°C/min)	Final Temp (°C)	Final Time (min)
Init		120	0.82
1	35.6266	160	0.00
2	14.2506	260	0.00

Total Run Time: 13.64 min

Method Translation Software

Switch from He to H₂ or N₂ carrier gas

Don't switch carrier gas type but try faster velocities

Different column dimensions

Combination of all the above

Link to software download:

<https://www.agilent.com/en-us/support/gas-chromatography/gcmethodtranslation?searchTermRedirect=gc%20method%20translation%20software>

Helium Carrier Gas Alternative

Test Case: ASTM D6584 for free and total glycerin in biodiesel

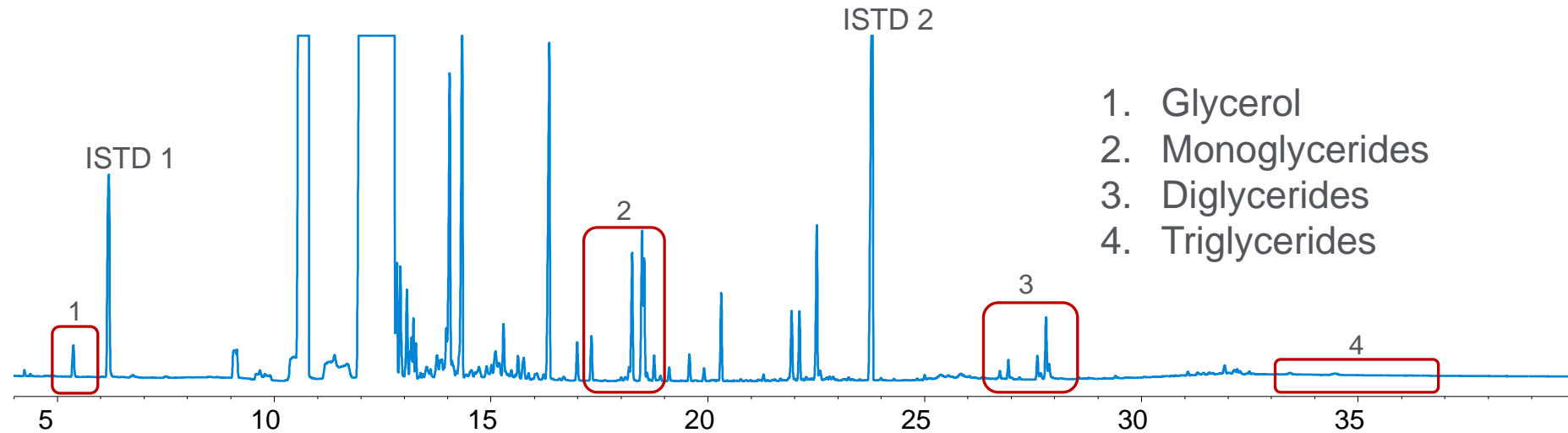

COC inlet:	Oven track mode
Precolumn:	Ultimetal 2 m x 0.53 mm id
Column:	Ultimetal DB5HT, 15 m x 0.32 mm id x 0.1 df
Column flow:	Helium at 3.0 mL/min (50 °C)
Column pressure:	7.63 psi constant pressure mode
Initial column temp:	50 °C for 1 min
Oven ramp 1:	15 °C/min to 180 °C
Oven ramp 2:	7 °C/min to 230 °C
Oven ramp 3:	30 °C/min to 380 °C, hold 10 min
Detector:	FID with 25 mL/min N ₂ makeup

Wider Retention Time Variation Using the Same Flow as the Original Helium Method

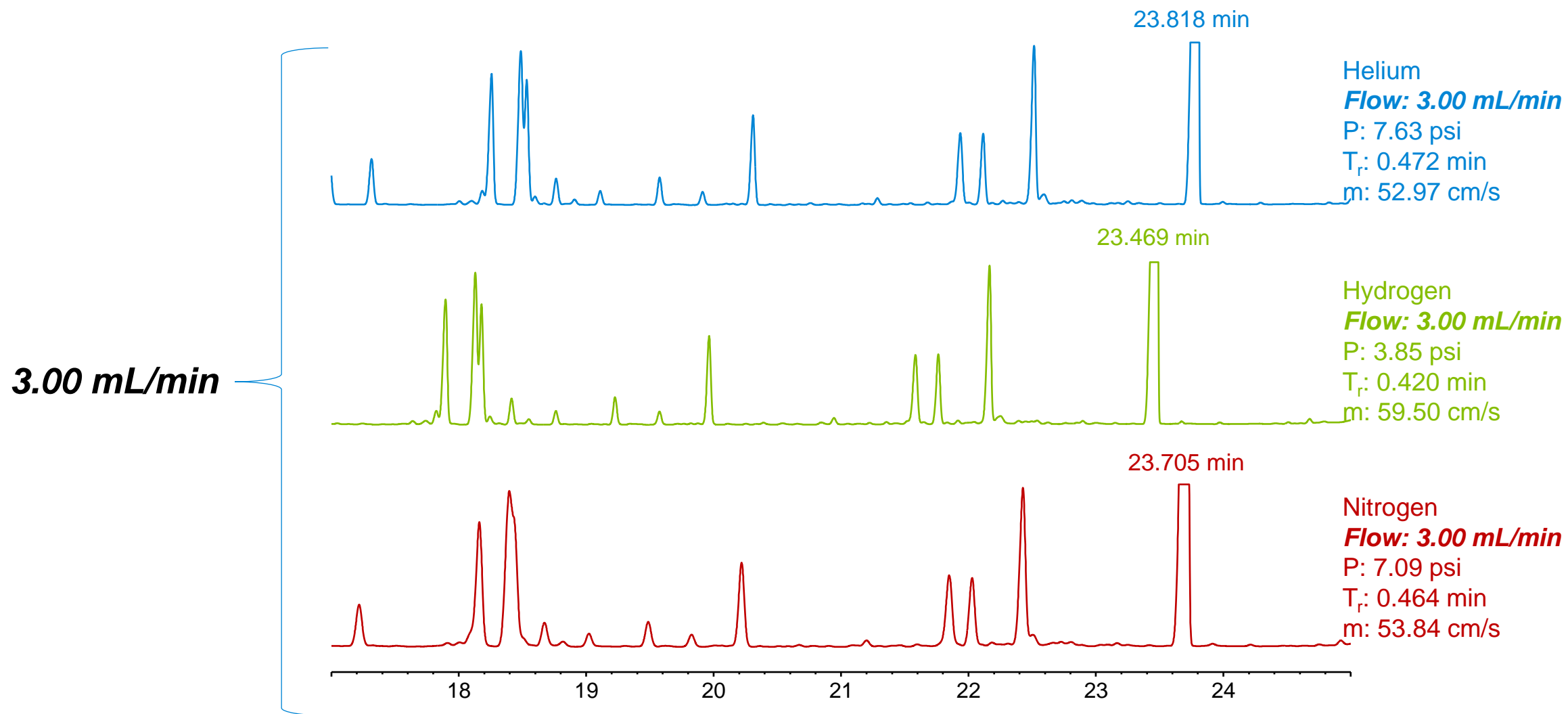

Set the Flow/Pressure Based on Holdup Time

Try the same flow or holdup time of the original helium method

The screenshot displays the 'Setup Method' window for an Agilent 7890A. The top graph plots temperature (°C) and flow (mL/min) against run time (min). The temperature (red line) starts at 0°C and rises to 400°C by 21 minutes. The flow (green line) starts at 3 mL/min and decreases to approximately 1 mL/min by 21 minutes. The configuration panel below the graph shows the following settings:

Parameter	Value
Flow	3 mL/min
Pressure	7.6296 psi
Average Velocity	52.99 cm/sec
Holdup Time	0.47179 min

The 'Flow' and 'Holdup Time' fields are highlighted with red boxes. The 'Control Mode' is set to 'On'. The 'Post Run' pressure is set to 7.6 psi. The 'Column #1 Configuration' section includes buttons for 'Change Column...' and 'Calibrate Column...'. The bottom of the window has 'OK', 'Apply', 'Cancel', and 'Help' buttons.

Same Holdup Time (T_r) Gives Consistent Retention Times Compared to Original Helium Method

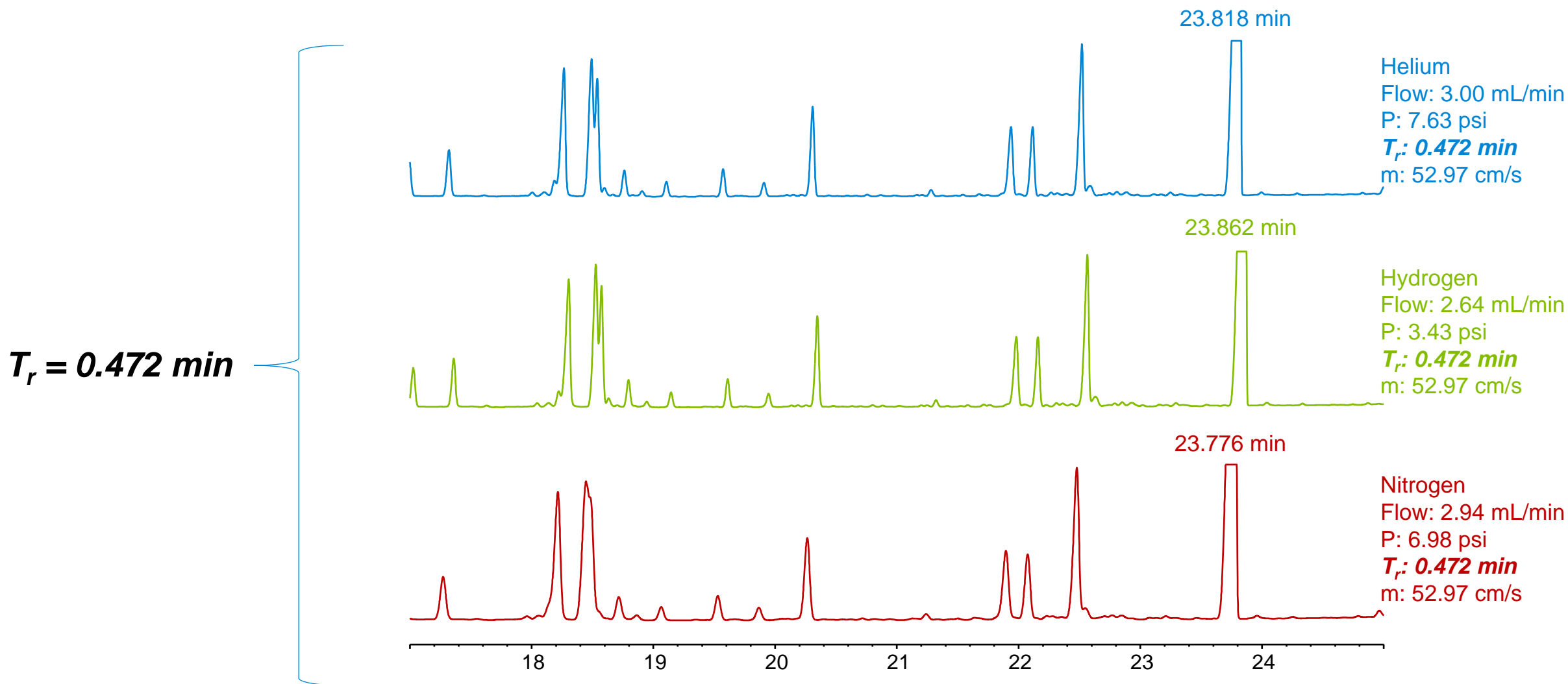

Monoglyceride Resolution “Good Enough” Using Nitrogen Carrier

All monoglycerides are summed for final reporting

High resolution of isomers is therefore not required

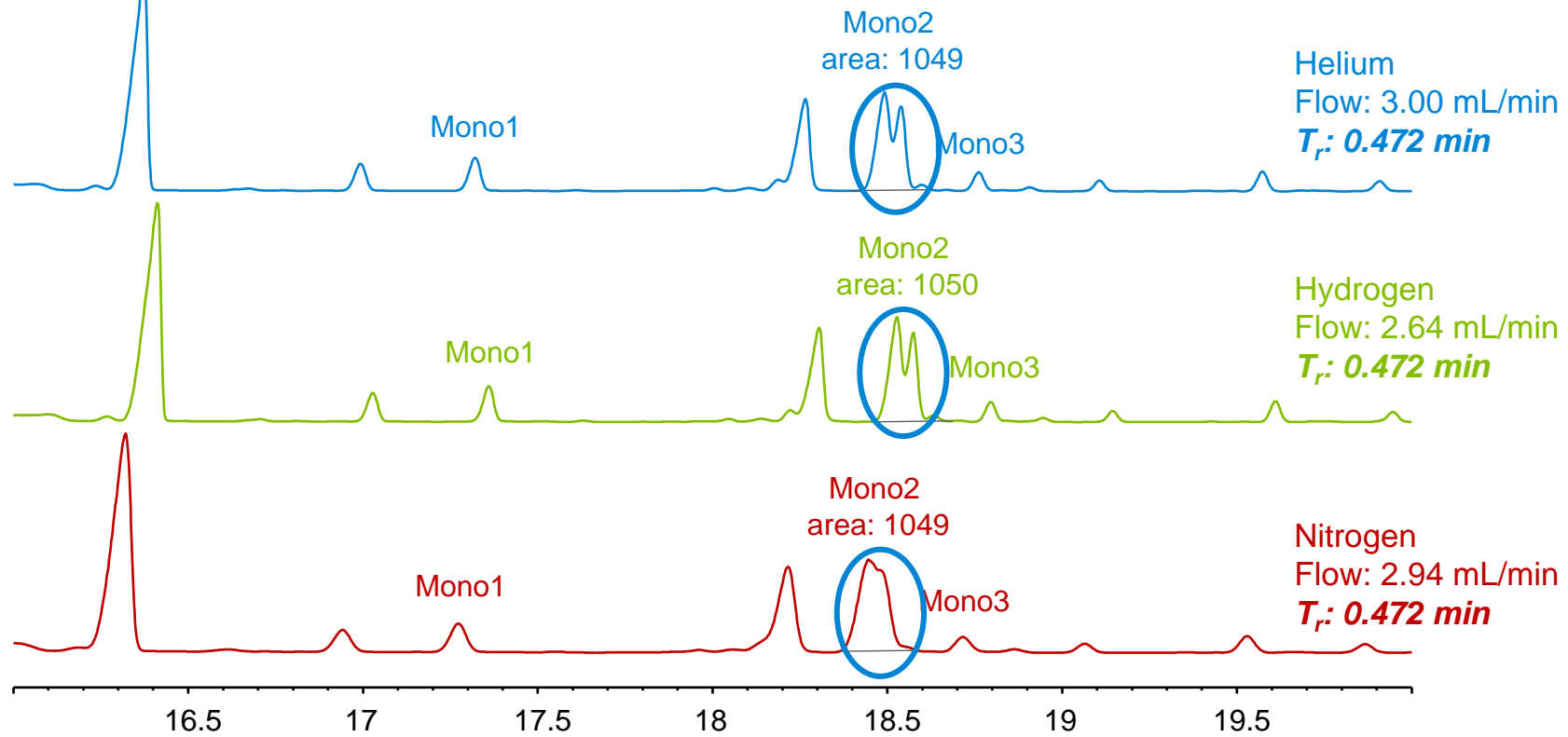

ASTM D6584 - Quantitative Results for Alternative Carrier Gas

Carrier gas has no effect on reported results

	Weight (%)		
	Helium	Hydrogen	Nitrogen
Glycerin	0.015	0.014	0.013
Monoglycerides	0.226	0.216	0.223
Diglycerides	0.114	0.115	0.110

Analysis of Oxygenates and Aromatics in Gasoline Using 2-D Gas Chromatography

ASTM Method D4815 – Oxygenated additives

- Ethers and alcohols from 0.1 wt% to 15 wt%
- Usually only one or two additives in a sample

Preliminary separation removes light hydrocarbons from sample

- Polar TCEP micropacked columns retain ethers and alcohols
- Back flush TCEP* column to nonpolar capillary column (HP-1) to complete analysis

* TCEP = 1,2,3-tris(2-cyanoethoxy)propane

Configuration and Operation for D4815 and D5580

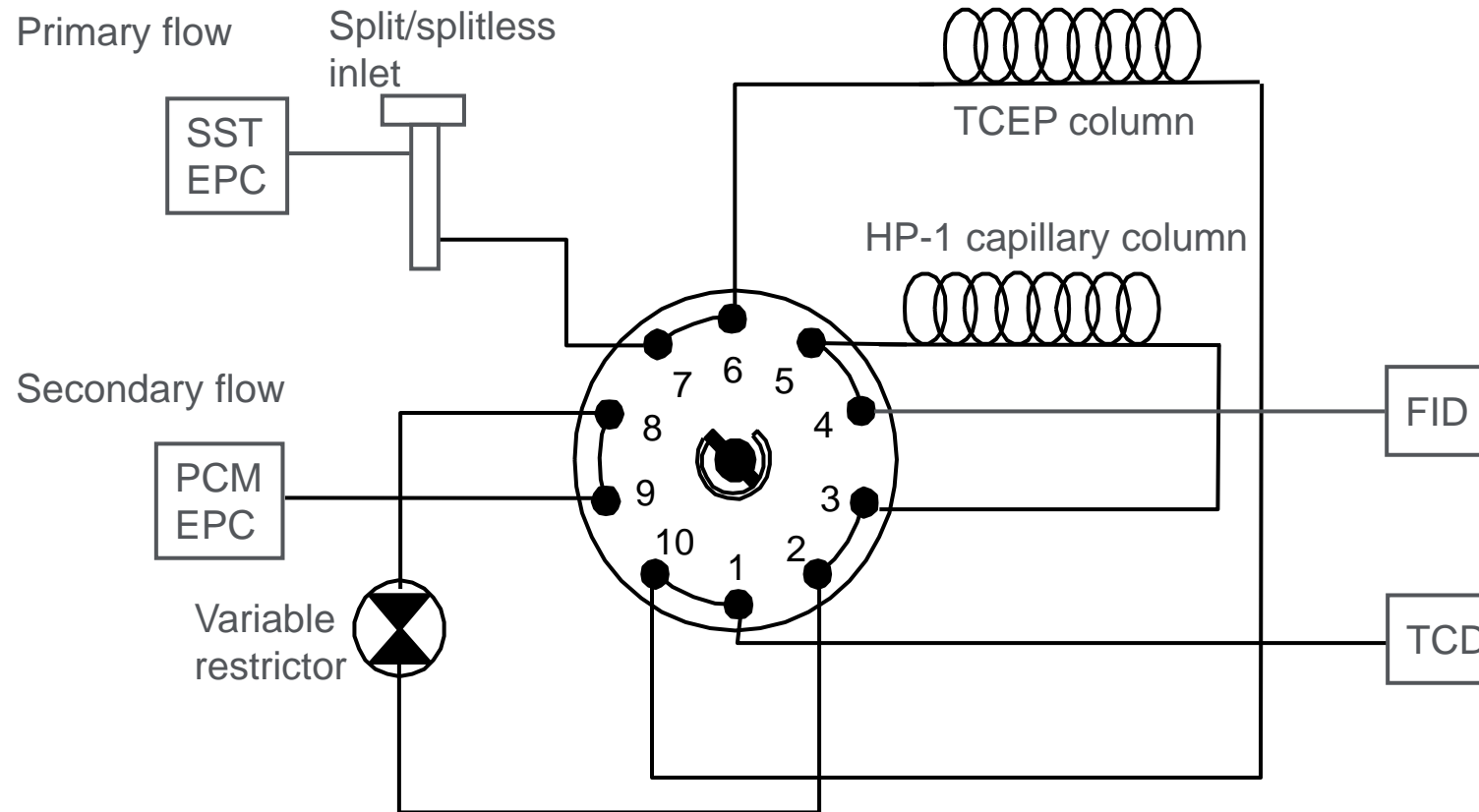

Instrument Conditions

Use nitrogen carrier gas with original ASTM GC flow conditions

Method D4815	
Carrier gas	Nitrogen
Inlet	Split/splitless
Inlet Temperature	200 °C
Inlet pressure	9 PSI (constant P)
TCEP column flow	5 mL/min
Split ratio	15 : 1
Split flow	70 mL/min
PCM pressure program	13 PSI for 14 min 99 PSI/min to 40 PSI
HP-1 column flow	3 mL/min
FID Temperature	250 °C
Oven Temperature	80 °C Isothermal
Run time	16 minutes

Analysis of MtBE and Ethanol in Gasoline Using N₂ Carrier Gas

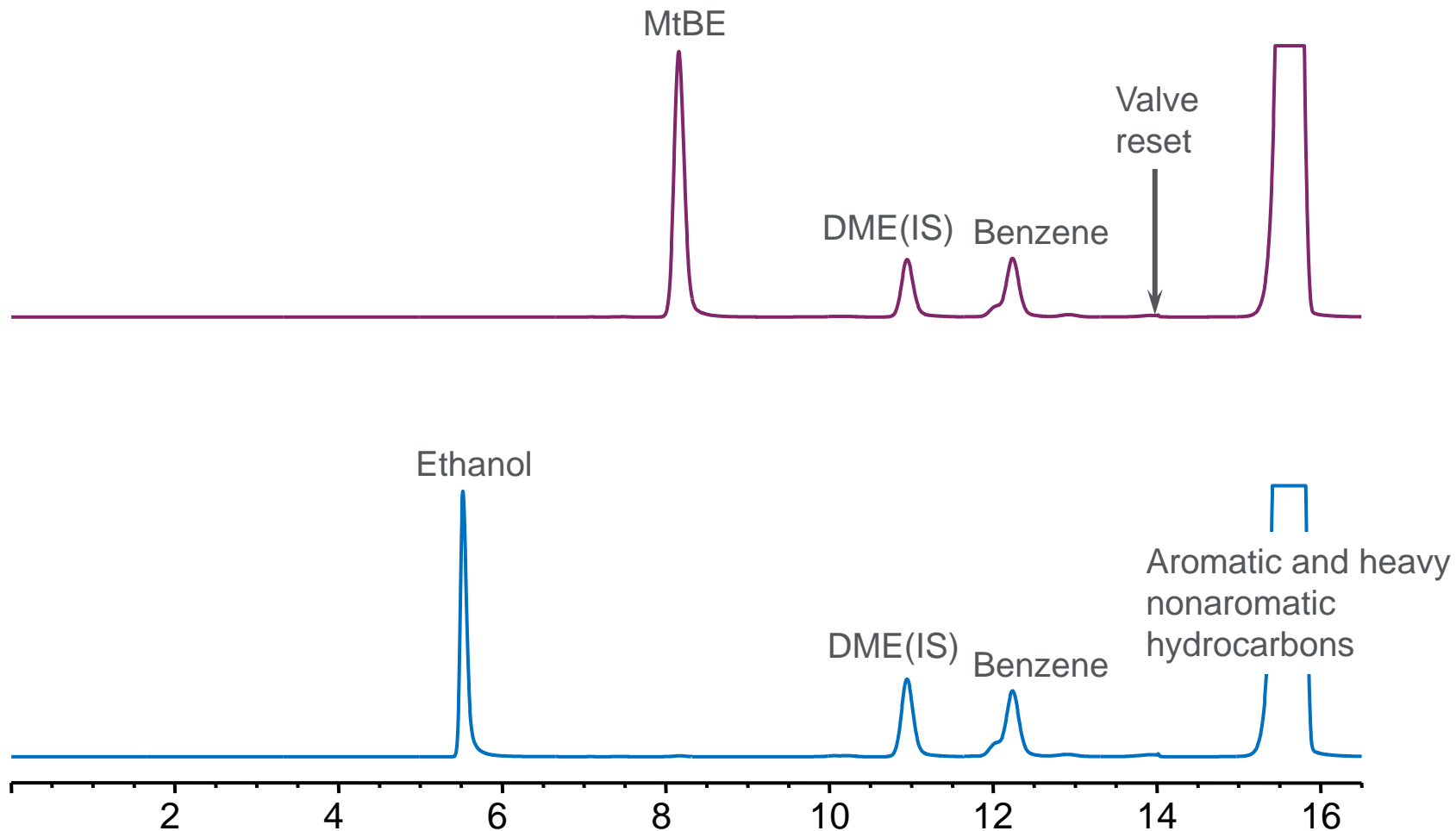

ASTM Precision Specifications

D4815 precision measures

Compound	Mass %	Repeatability		Reproducibility	
		Spec	Observed	Spec	Observed
Ethanol	0.99	0.06	0.01	0.23	0.01
Ethanol	6.63	0.19	0.03	0.68	0.04
MtBE	2.10	0.08	0.01	0.20	0.01
MtBE	11.29	0.19	0.05	0.61	0.08

Accuracy evaluation

Sample	MtBE mass %	
	known	found
SRM2294 #1	10.97	10.61
SRM2294 #2	10.97	10.60
AccuStd Check	12.00	11.81

Carrier Gas Decision Tree

Migrating GC methods to nitrogen and hydrogen

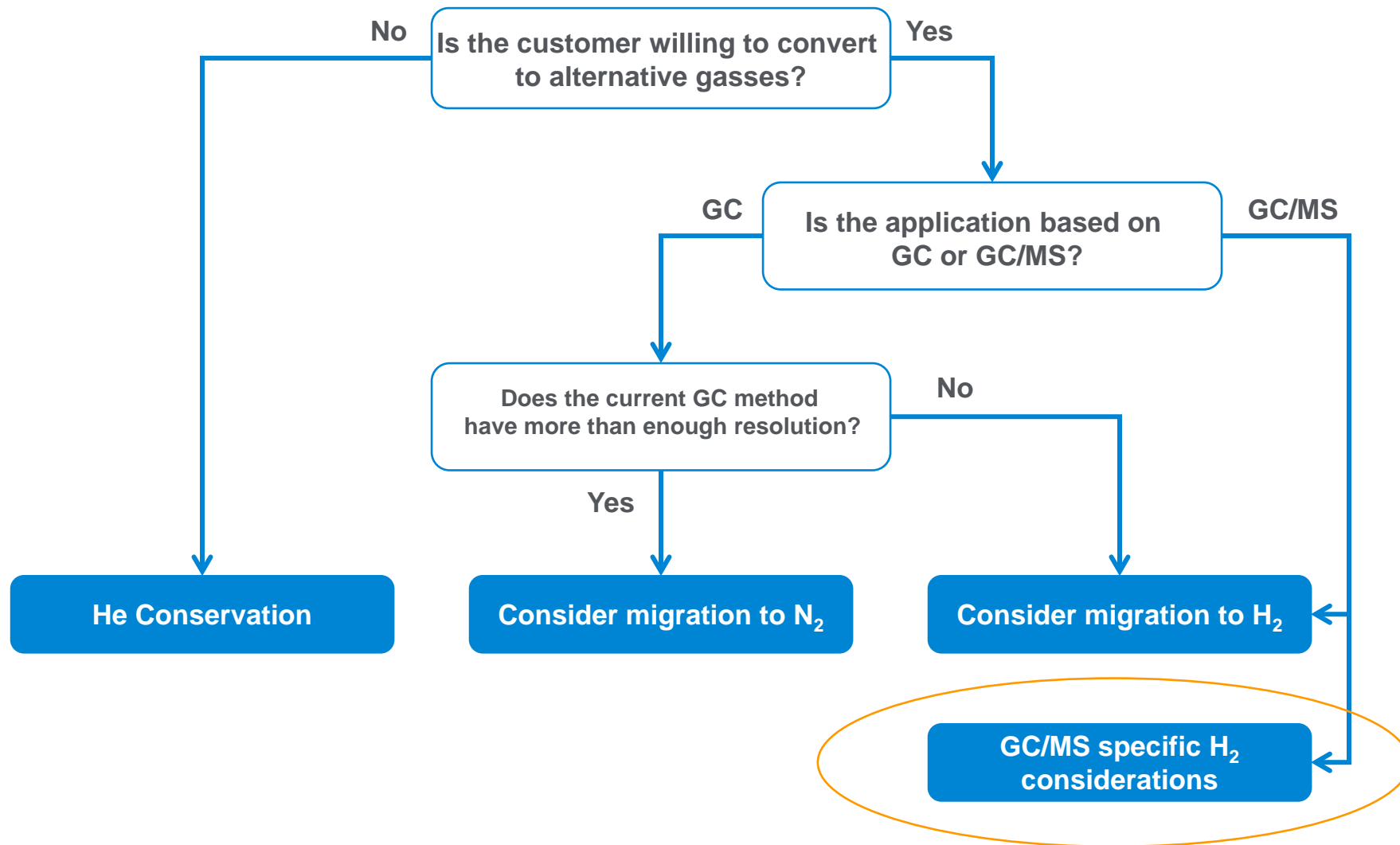

MSD Systems: **Do Not** Switch from He to H₂ Unless Absolutely Necessary

- Hydrogen is a reactive gas!
- You **will** experience a noisy/elevated background that can be persistent (days/weeks/longer?)
- Chemical reactions happen in the inlet, column, and sometimes the source that can change your results.
- **Every** analyte in **every** matrix in **every** method will need to be validated using hydrogen to make sure there are no chemical reaction problems (unlike using a Helium conservation module)
- Looking for untargeted unknowns is problematic due to the possibility of reactivity.
- Library search match quality will be impacted.
- Tuning results will be different than with helium. Some tunes, notably BFB and DFTPP, may not pass
- **First, try all helium conservation measures instead of switching to H₂.**

***There are no published performance specifications for any current Agilent GCMS system using hydrogen carrier gas.**

MSD: Converting from He to H₂ Carrier Gas

- Many GC/MS users are considering changing from helium to hydrogen carrier gas due to price/availability problems with helium.
 - Read [Chemical and Engineering News - July 16, 2012 \(Page 32-34\)](#)
- It is important to recognize the differences with using hydrogen carrier. Time should be allotted for adapting the method, optimization, and resolving potential problems. Areas that will need attention include:
 - choice of supply of H₂
 - GC/MSD hardware changes
 - choosing new chromatographic conditions
 - potential reduction in signal-to-noise ratio (2-5x or more) due to higher noise
 - changes in spectra and abundance ratios for some compounds
 - activity and reactivity with some analytes

***There are no published performance specifications for any current Agilent GCMS system using hydrogen carrier gas.**

Carrier Gas Decision Tree

Continue using helium, but in a smarter way

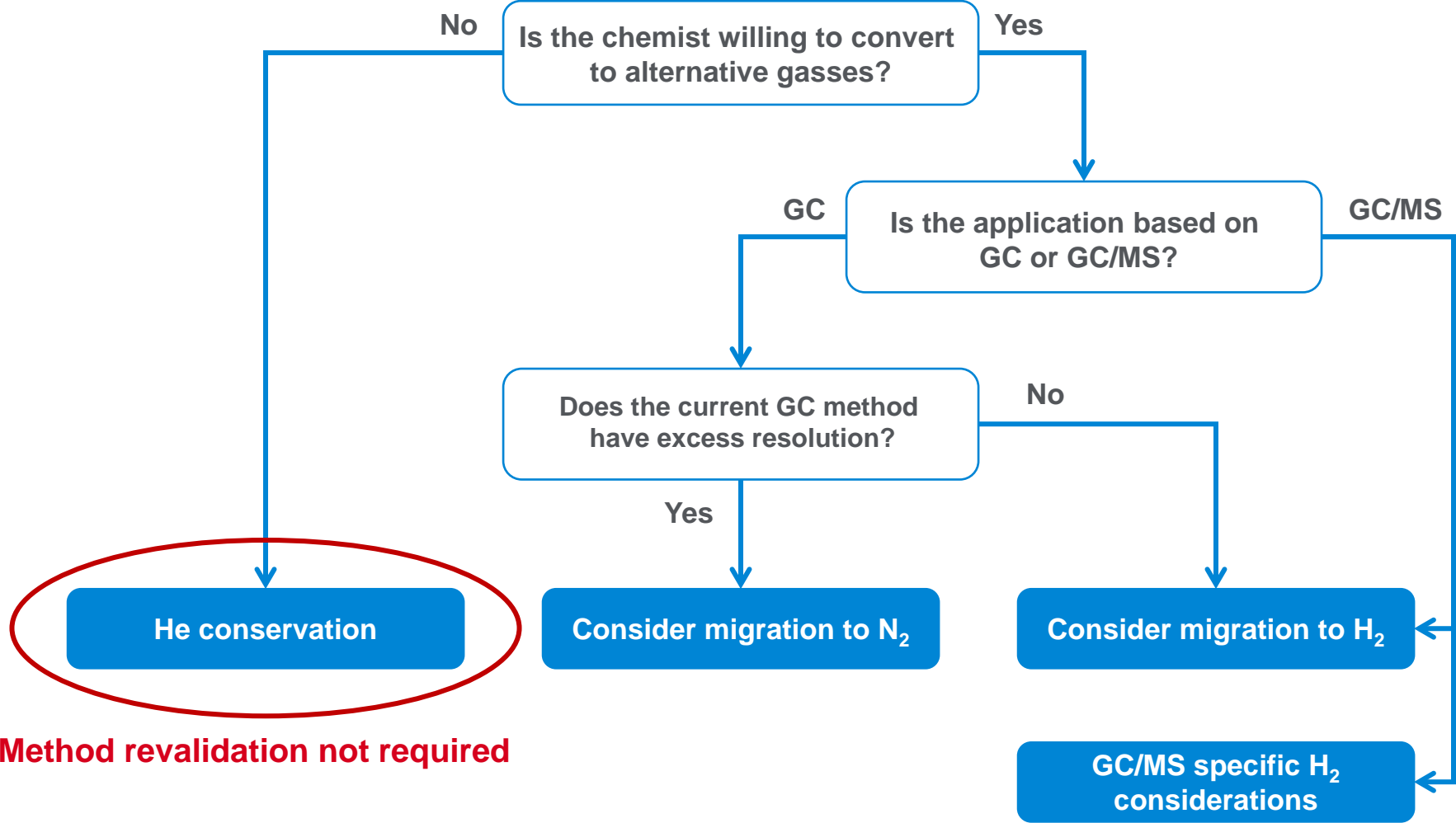

Reducing Helium Use With Conservation

Programmable helium conservation module (available for Agilent 7890B, 8860, 8890 GC systems including MSD)

- Automatically switches carrier gas supply to N₂ standby during idle time
- Integrates into the Sleep and Wake function of the GC
- Combined with Helium Gas Saver to **greatly** reduce helium consumption
- Better alternative to just “shutting off the GC”
 - No system contamination with ambient air exposure
 - Faster restart of heated zones

Helium Conservation Module

Seamlessly integrated onto GC hardware and software

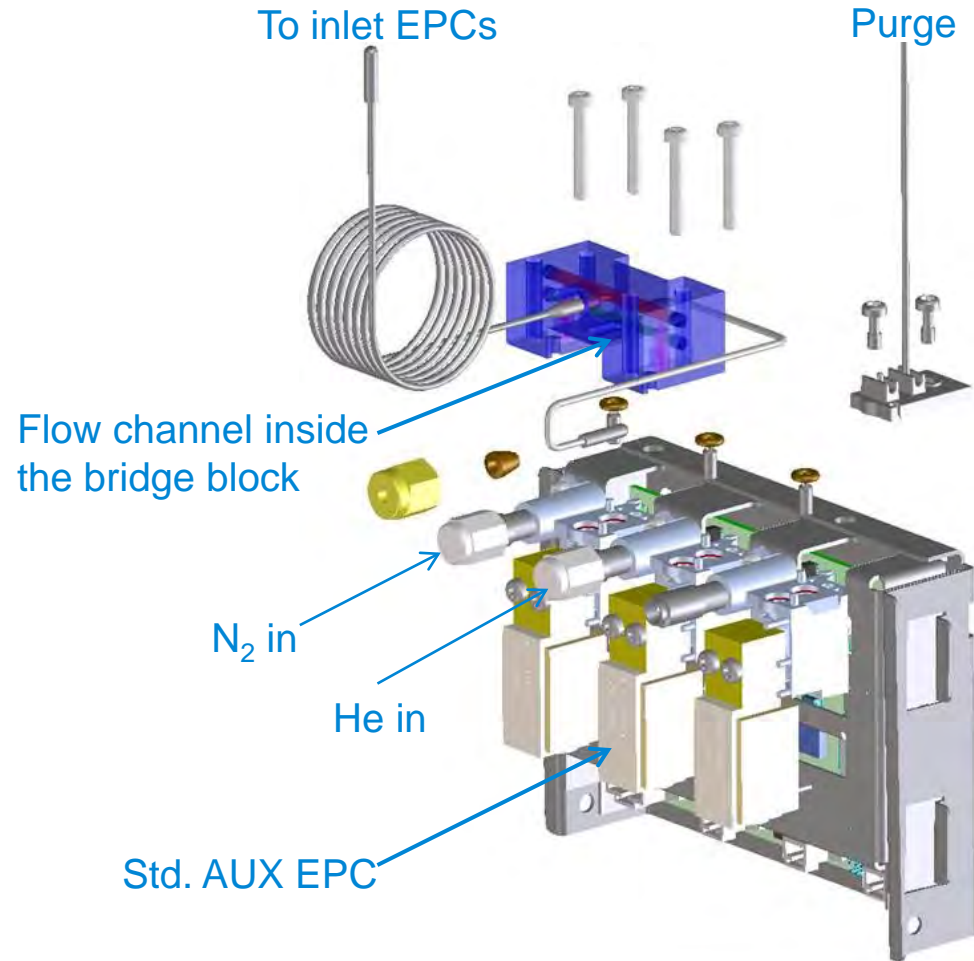

- Built on 5th generation EPC
- Fully controlled by Agilent data systems
- Purge channel prevents cross contamination of gases
- Precise pressure control between tank and GC
- Switch between gases within 15 to 30 min for most detectors

How Does It Work?

Normal operation mode (helium carrier or wake mode)

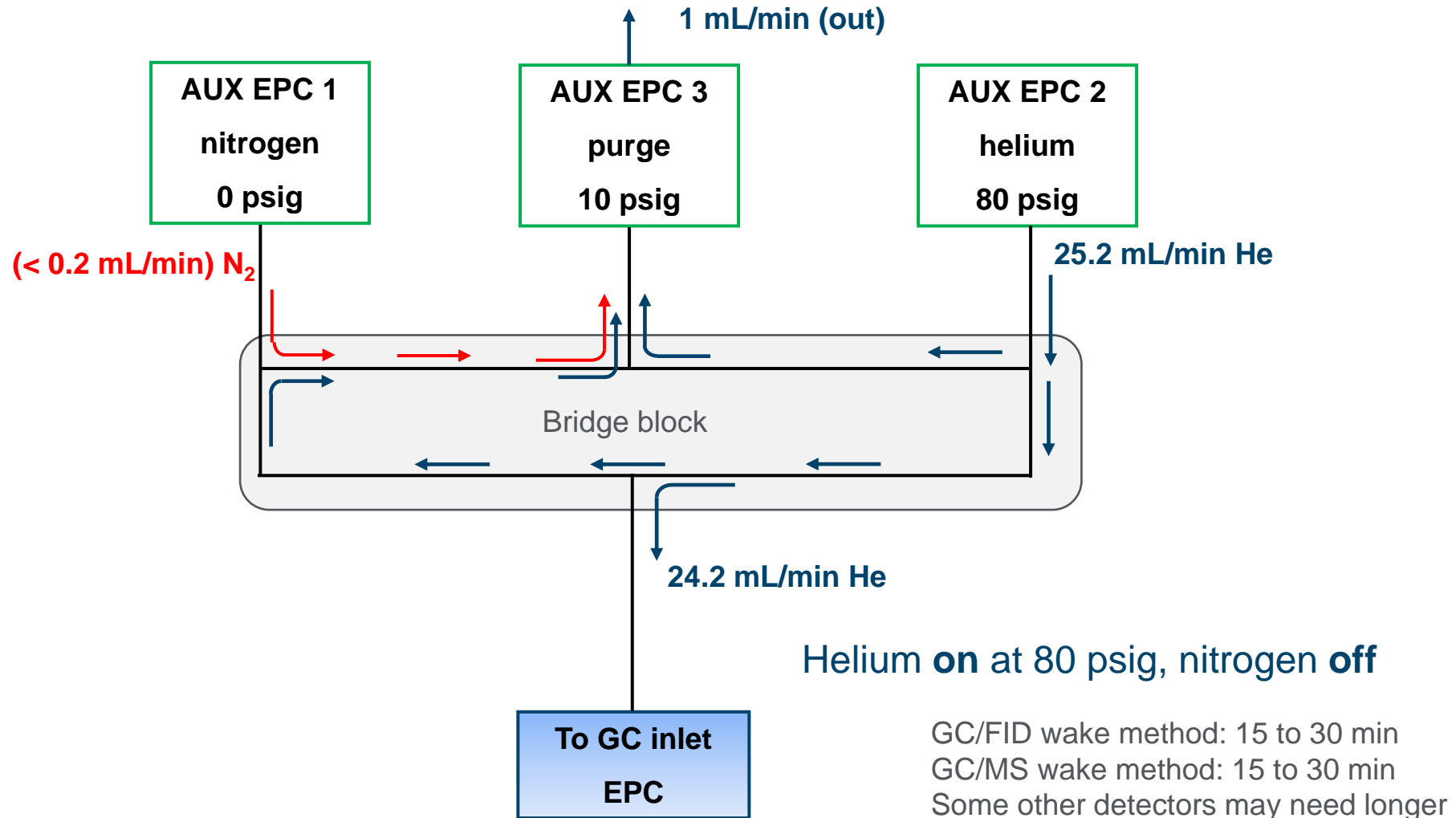

How Does It Work?

Helium savings mode (nitrogen carrier, or sleep mode)

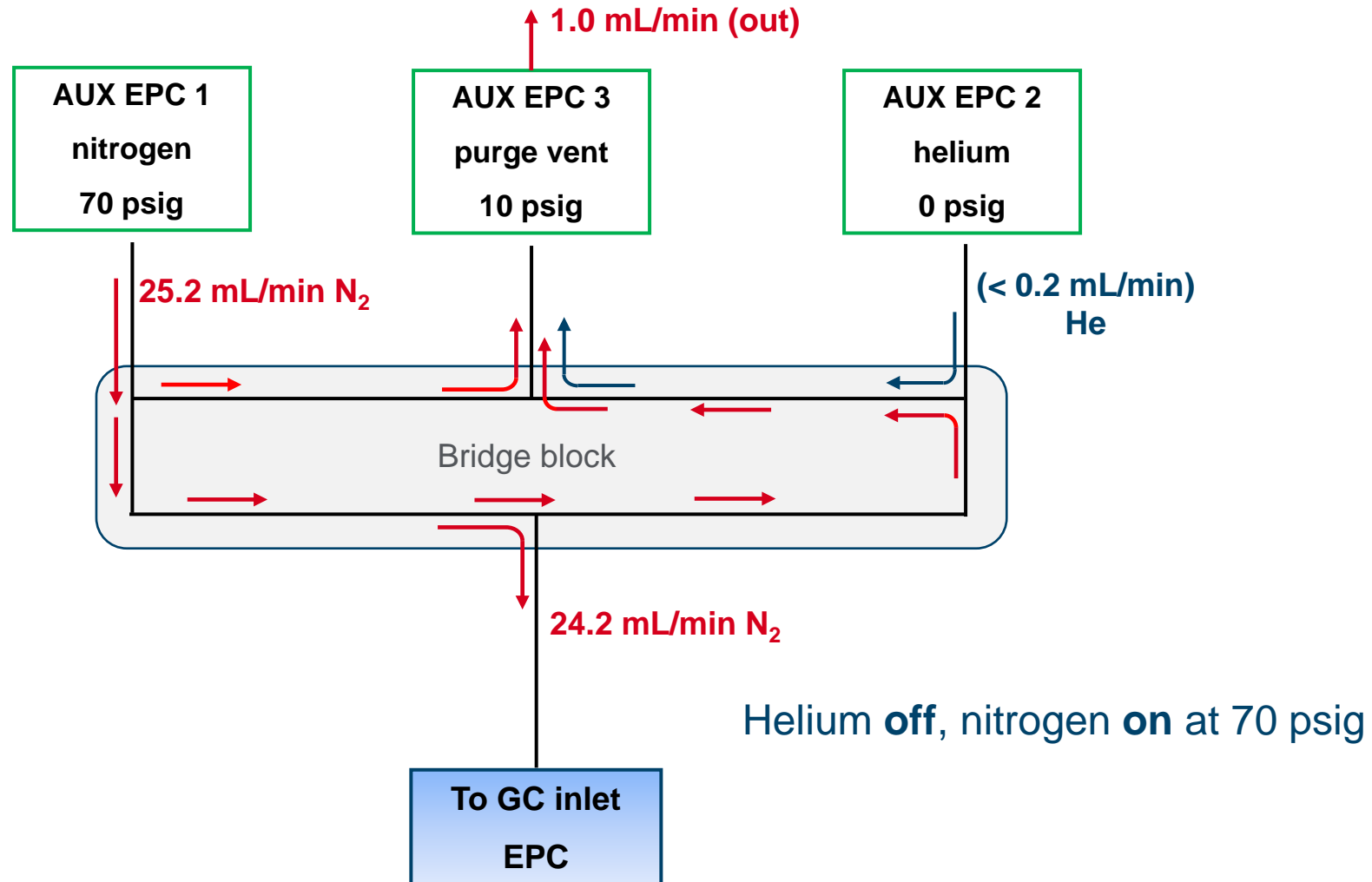

How It Works: Configuring Sleep/Wake Operation

Simple, straight forward setup

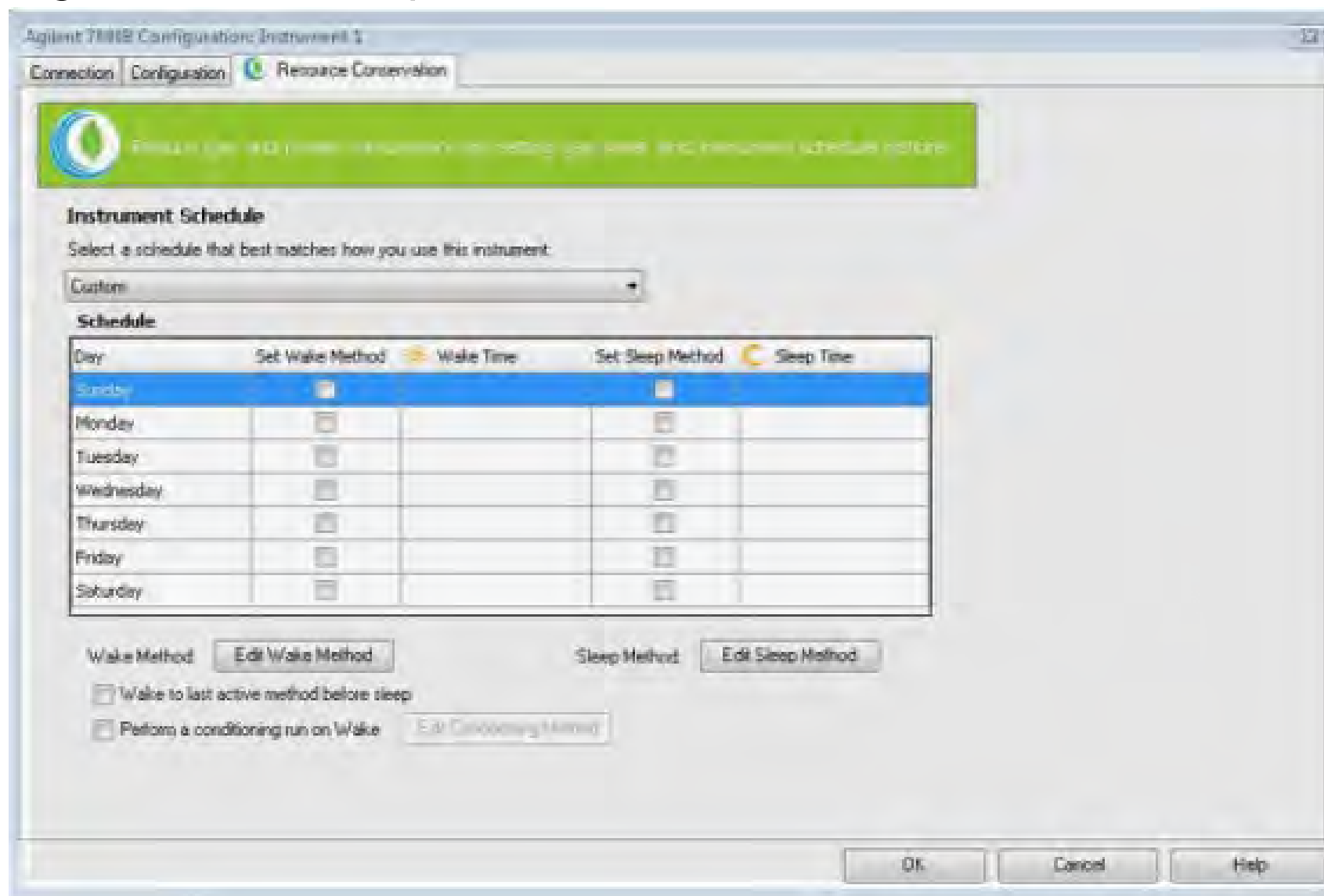

Performance: GC/FID Analysis

Day 1 - Original He carrier gas run

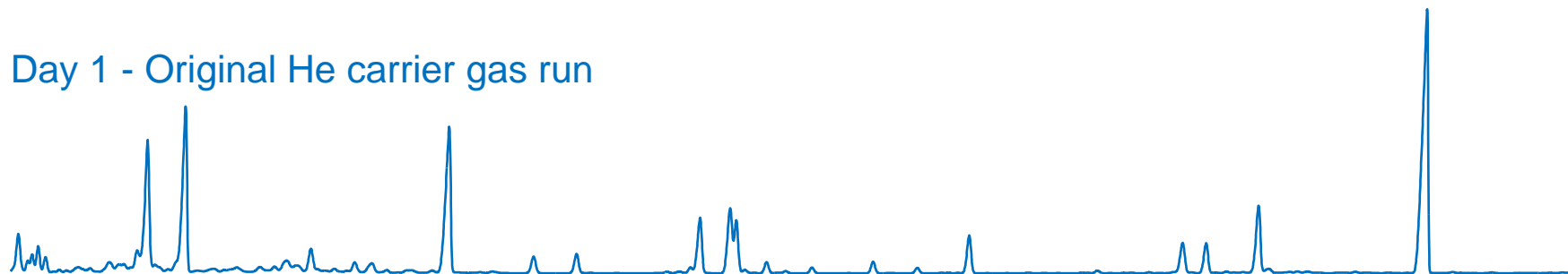

Day 2 – First He carrier gas run after overnight N₂ Sleep.M method



Day 3 – First He carrier gas run after overnight N₂ Sleep.M method

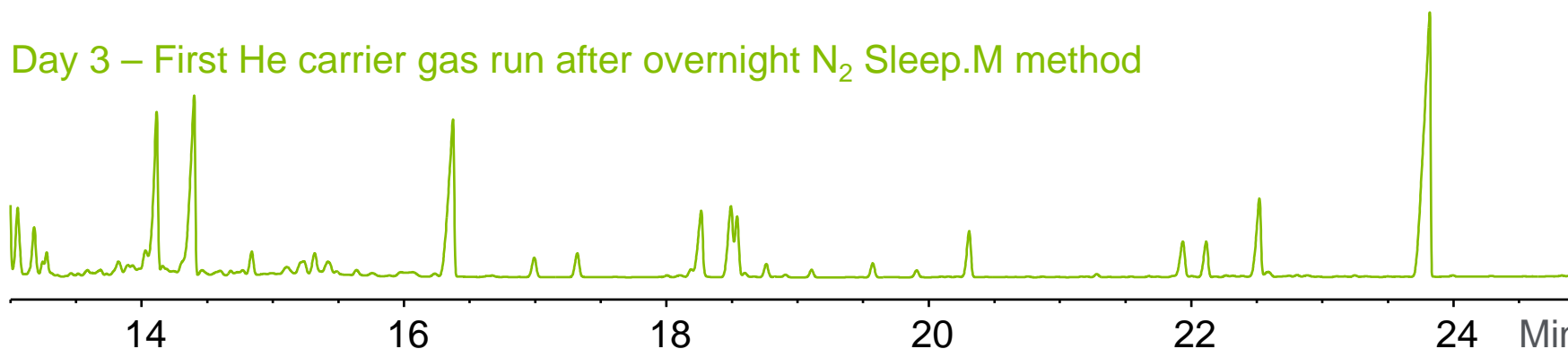

No change in chromatography after N₂ carrier Sleep method.

Performance: MS Tune

Passes Within 15min After Switching From N₂ to He As Carrier. GC/MSD

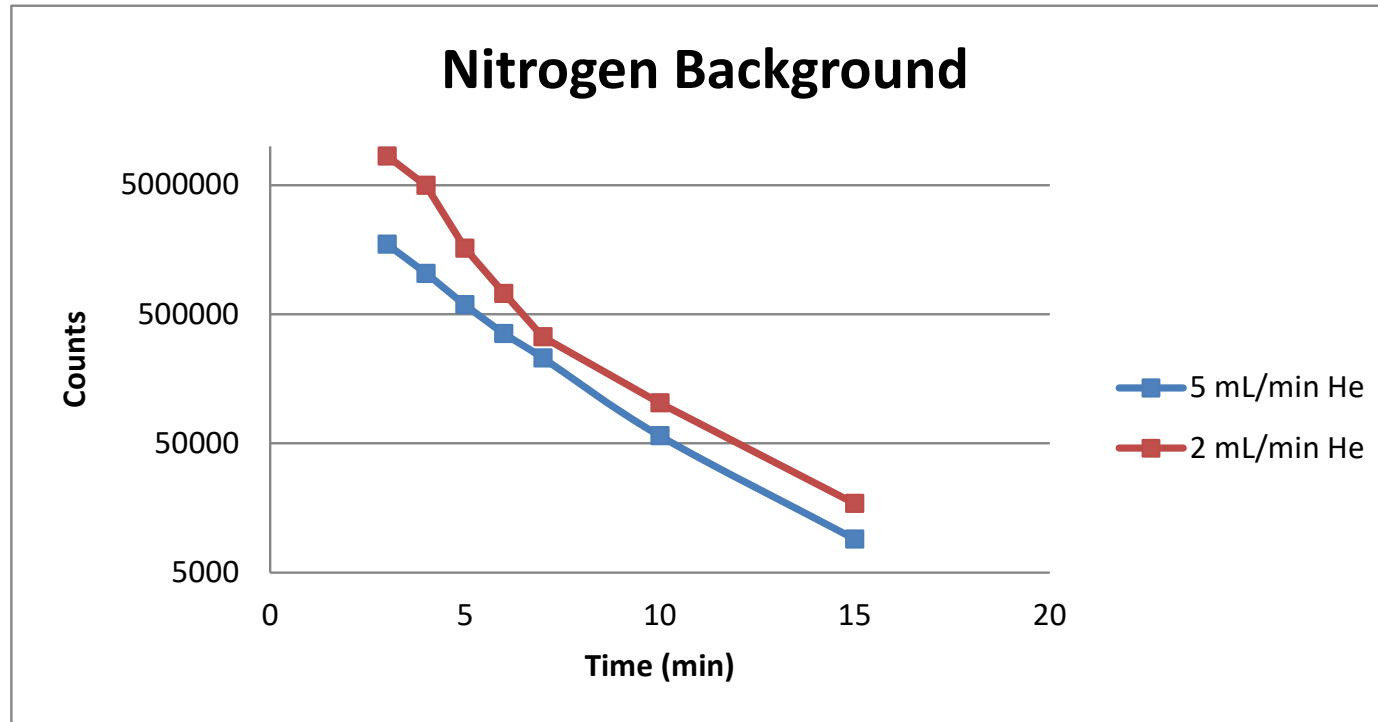

Time (min)	Counts of Nitrogen Ion			
	5 mL/min He	Relative to Saturation	2 mL/min He	Relative to Saturation
3	1735168	20.69%	8388096	100.00%
4	1033280	12.32%	4959232	59.12%
5	590080	7.03%	1618944	19.30%
6	354112	4.22%	722944	8.62%
7	228480	2.72%	333696	3.98%
10	56984	0.68%	102576	1.22%
15	9052	0.11%	17080	0.20%

Helium Savings– Single GC Channel

Extend helium supply and lower cost using conservation techniques

Agilent Technologies

Method: ASTM D4815 - Ethanol in Gasoline
Column: PDMS 30m x 0.53mm x 2.65um

GC Flow Conditions

He Carrier Flow (mL/min):	8
He Split flow (mL/min):	70
Gas Saver Flow (mL/min):	20
Gas Saver On (min):	3
Run Time(min.):	20
Gas Volume in Cylinder (L):	8000
Runs per Day:	30
He Cylinder Cost (\$):	300
N2 Cylinder Cost (\$):	60

Parameter	No Conservation	Helium Conservation
Daily He Usage (L)	112	21
He Cylinder Life (days)	71	376
Daily N ₂ Usage (L)	0	24
N ₂ Cylinder Life (days)	0	340
Yearly He Cost (\$)	\$1,537	\$292
Yearly N2 Cost (\$)	\$0	\$64

Example

- ASTM Method D4815
 - Widely used to measure ethanol in gasoline
 - Helium cylinder last two months under normal operation

- Helium conservation
 - Helium cylinder life extended to 12 months
 - 4x yearly gas costs per year

Yearly total gas cost	\$1,537	\$356
------------------------------	----------------	--------------

Alternative for Older Systems (or Non-Agilent Systems)

- Use of a 3-way stream selection valve to manually switch between N₂/He
 - Plumb N₂ to one input and He to the other and switch valve as needed
 - Not automated/integrated strictly manual
 - No purge channel



Agilent CrossLab CS (Cartridge System)

No peaks from leaks

Features:

- Exchangeable cartridge with ADM Flow Meter
- Automatic Notification of Probe Filter Replacement
- Ergonomic and robust design
- Universal 3AA or USB power
- USB connects to web interface for added functionality and firmware updates
- Easy to view OLED Screen
- Kickstand

Leak detector
cartridge

Handheld



ADM Flow Meter
cartridge

Ordering Guide

G6693A – CrossLab CS Electronic Leak Detector

G6694A – Electronic Leak Detector Cartridge

G6699A - CrossLab CS Bundle: ADM Flow Meter and Electronic Leak Detector

- The bundle will include 1 handheld, 2 cartridges, and a free carrying case.

G6694-60005 – Replacement Probe Filter

G6691-40500– Carrying Case



Existing products:

G6691A – CrossLab CS ADM Flow Meter

G6692A – ADM Flow Meter Cartridge*

- Note that the ADM Flow Meter cartridge is ordered annually for calibration. The Electronic Leak Detector does not need to be recalibrated!

GC/MS Migration to H₂ Carrier Gas

Recent C&EN webinar discussion points

Read the hydrogen safety guide before proceeding:

<https://www.agilent.com/cs/library/usermanuals/public/Hydrogen.pdf>

- System setup
 - H₂ safety, H₂ source, gas connection, system clean up
- Method migration
 - Method transfer SW, method migration consideration, revalidation
- GC/MS analytical performance expectation
 - Sensitivity impact, MS spectrum impact, analyte compatibility
- For more details
 - C&EN webinar on October 9, 2012
 - Recorder session: http://cen.acs.org/media/webinar/agilent_100912.html

Summary: Helium Conservation Benefits

- Seamless integration
 - No need to revalidate existing GC methods
 - Fully integrated with Agilent 7890B and CDS (OpenLab, Mustang, MassHunter)
 - Carrier gas ID and setpoints are a part of the method for compliance and transfer
 - Easily implemented using new Agilent Sleep/Wake functions
- Greater reliability
 - Based on proven 5th generation AUX EPC
 - Agilent 7890/8890 provides warning if setpoints are not reached
 - For hydrogen users, nitrogen substitution when not running GC
- Greater performance
 - Purge channel prevents cross contamination of gases
 - Delivers more stable gas pressure control from the tank regulator to the inlet EPC module
 - Acts as an intermediate pressure regulator from the tank to inlet EPC to ensure greater analytical precision

Summary – Migration to H₂ and N₂

- Don't forget about Gas Saver
- Be especially cautious when migrating to H₂ with an MSD system
 - Generally, not recommended
- For high resolution methods, H₂ offer the best alternative
 - Agilent GC and GC/MS systems have many built-in safety features
- For many GC applications, N₂ offers a cheap, easy alternative without any safety worries
 - Many existing helium methods have too much resolution
 - N₂ can be used without changing any of the existing GC conditions
 - Keep the holdup time the same as the original method
 - 2-D methods have high resolution built in, so N₂ is ideally suited as a carrier gas
 - Valve-based or Deans switch (not GC x GC flow modulation)
- For more information on Helium Carrier Gas:
www.agilent.com/chem/heliumupdate
- ASMS: 6/5-6/9 (Special announcement regarding H₂ carrier + MSD!)
 - <https://agilent.cventevents.com/event/00991e46-413f-4029-8b73-0c8815f04fa0/summary>

Agilent University

Why training? What can we help with?

Agilent University:

- Trained over 38 K students FY19
- 98% customer recommended
- 4.6 out of 5 customer satisfaction
- 94% excellent and very good

Labs who want faster and more efficient learning options to help overcome training challenges

Overtasked staff

Staff turnover

Pressure to improve quality and productivity

Daily consistency with output and results

Reduce costs associated with lab operations

Virtual training

Flexible and convenient training options when and where you need it:

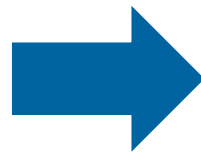

Virtual Instructor Led



eLearning self-paced

In-person training



Classroom



Onsite or Virtual onsite

<https://www.agilent.com/en/training-events/events/agilent-education>

Trust Agilent for answers leveraging up-to-date knowledge and generally accepted practices for all your training needs

Contact Agilent Chemistries and Supplies Technical Support



1-800-227-9770 Option 3, Option 3:

[Option 1 for GC and GC/MS columns and supplies](#)

Option 2 for LC and LC/MS columns and supplies

Option 3 for sample preparation, filtration, and QuEChERS

Option 4 for spectroscopy supplies

Option 5 for chemical standards

Available in the USA and Canada 8–5, all time zones



gc-column-support@agilent.com

lc-column-support@agilent.com

spp-support@agilent.com

spectro-supplies-support@agilent.com

chem-standards-support@agilent.com

