



Making Better GC Column Connections

Abby Folk

Columns and Supplies
Applications Specialist

Agilent Technologies, Inc.

GC column installation is a challenge...

A routine, basic procedure but not easy to do

- Very small parts
- Wrenches in cramped, dark space

Two chances to get it wrong:
at the inlet and the detector

What can go wrong?

- Height into the fitting
- Leaks
- Activity

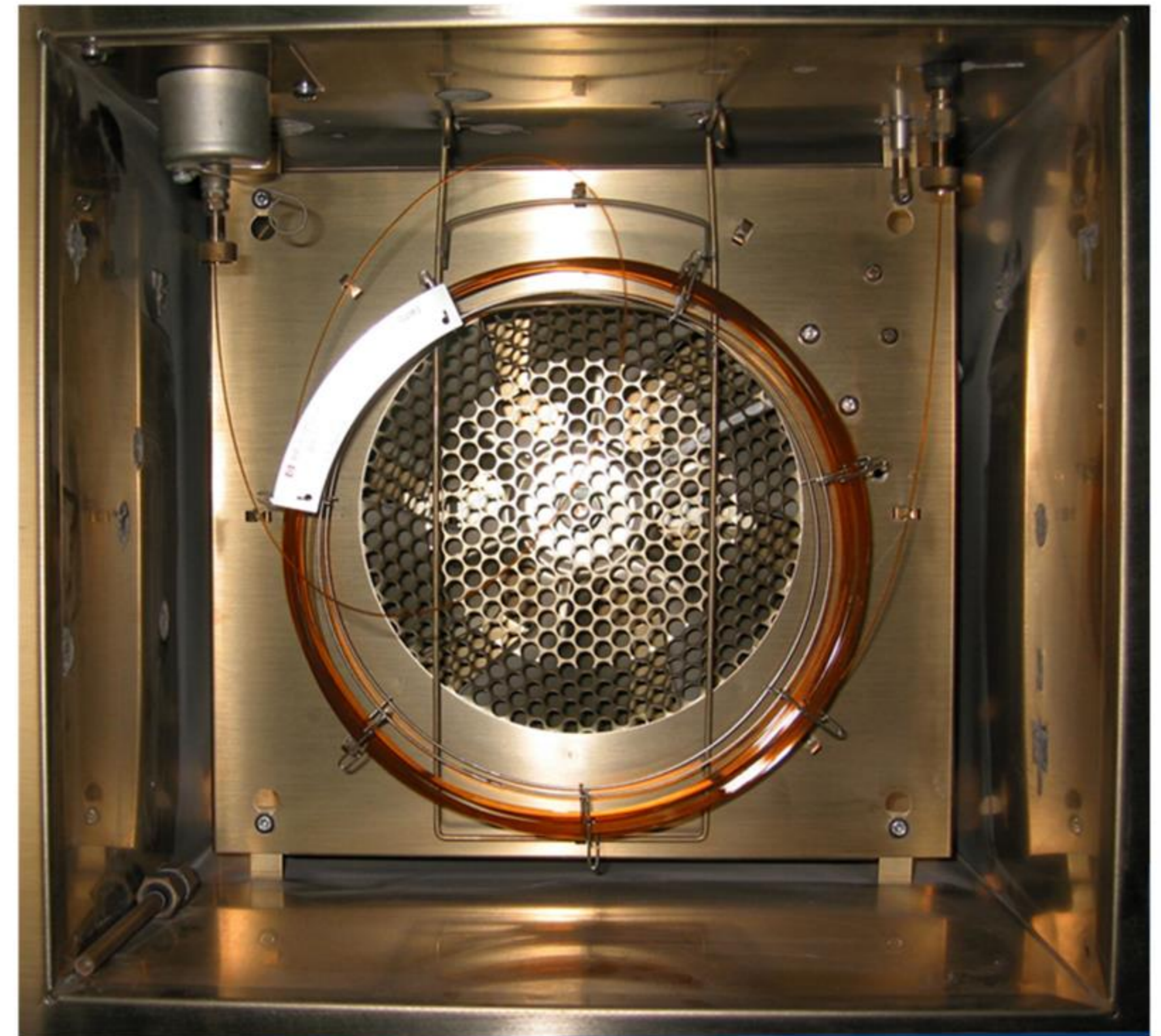

How do you make better GC column connections?

1. Start with the right tools and supplies

- Column nuts
- Material : stainless – but need brass for MS interface
- Choice of right ferrules

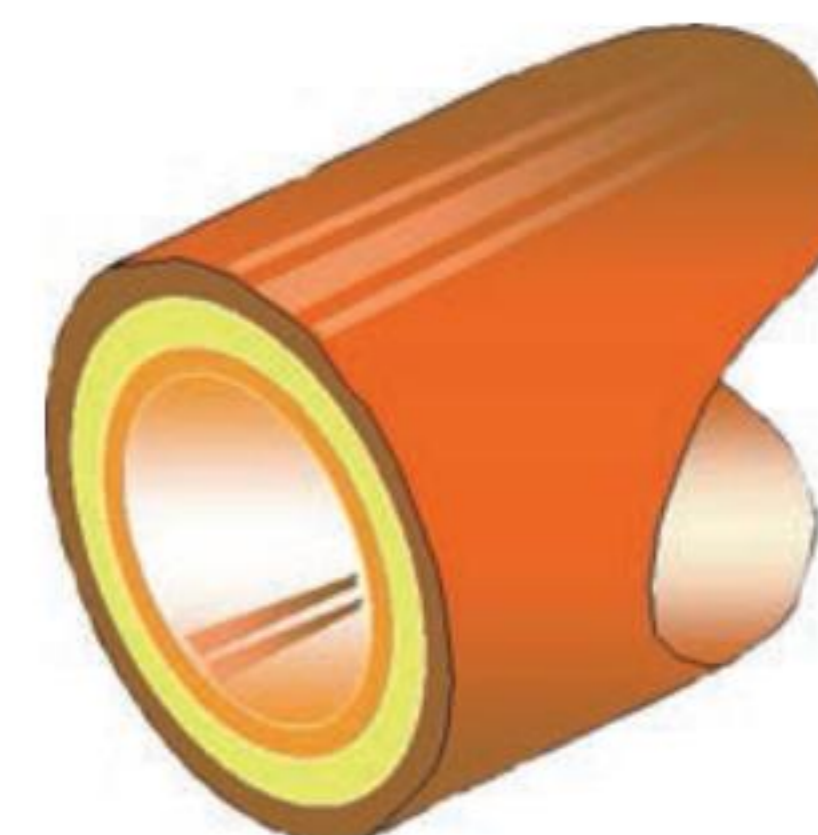

2. Proper assembly process

- Make a good clean column cut – every time
- After ferrule is installed
- Fused silica tubing cutters : ceramic, diamond tipped etc.
- Magnifier to inspect the cut - cracked fused silica and flaps of polyimide are active sites that ruin chromatography.

3. Ensure the proper and consistent length of column into the fitting

Supply Selection: Which Capillary Ferrules to use?



polyimide



polyimide/graphite



graphite



flexible metal

Composition	Re-use	Max T	Use	Limitation
Polyimide (Vespel)	yes	280	Easy seal	Shrink after heating causing leaks after thermal cycle; isothermal only
Graphite	yes	450	FID, NPD Inlets	Contamination, permeable to air – not for oxygen sensitive detectors
Polyimide/graphite (85% / 15%)	limited	350	MS, ECD, Inlets	Still shrink after thermal cycles creating leaks; need to retighten regularly
Flexible metal	no	450	Capillary Flow Technology (backflush, splitters,...)	May not seal well with damaged fittings or rough surfaces



“Short” ferrules for inlet and detector configurations on Agilent GC’s



“Long” ferrules for MS transfer lines and MS interface nut

Supply selection: Graphite Ferrules

Often selected because

- high temperature range (450C)
- the least expensive capillary ferrules
- Soft, easily conform to fitting shape and size

But do not over tighten!

Over tightening of ferrules

- Causes ferrule material to extrude into the fitting
- Creates active sites if in the flow path
- Can flake or fall apart, blocking flow path and requiring extensive maintenance

Remember Graphite is NOT recommended with MS, ECDs or with any Capillary Flow Devices. Graphite is permeable to air be very careful.

Active sites in the flow path



Extensive Inlet maintenance needed



Supply Selection: Graphite/polyimide blend ferrules

Graphite / polyimide (vespel) blend ferrules are very popular

- Recommend
 - Long style for Mass Spec
 - Short for Inlets, and other oxygen sensitive detectors, like ECD
- Soft enough to make seal against rough surfaces
- Fairly high temperature stability (350C)
- Don't extrude beyond the fitting when tightened (like graphite)
- Lower air permeability than pure graphite



Graphite / Polyimide blend capillary ferrules

Unfortunately ... leak following normal temperature program runs
Studies show the leaking continues with use of the ferrules -
Not just after the first one or two runs

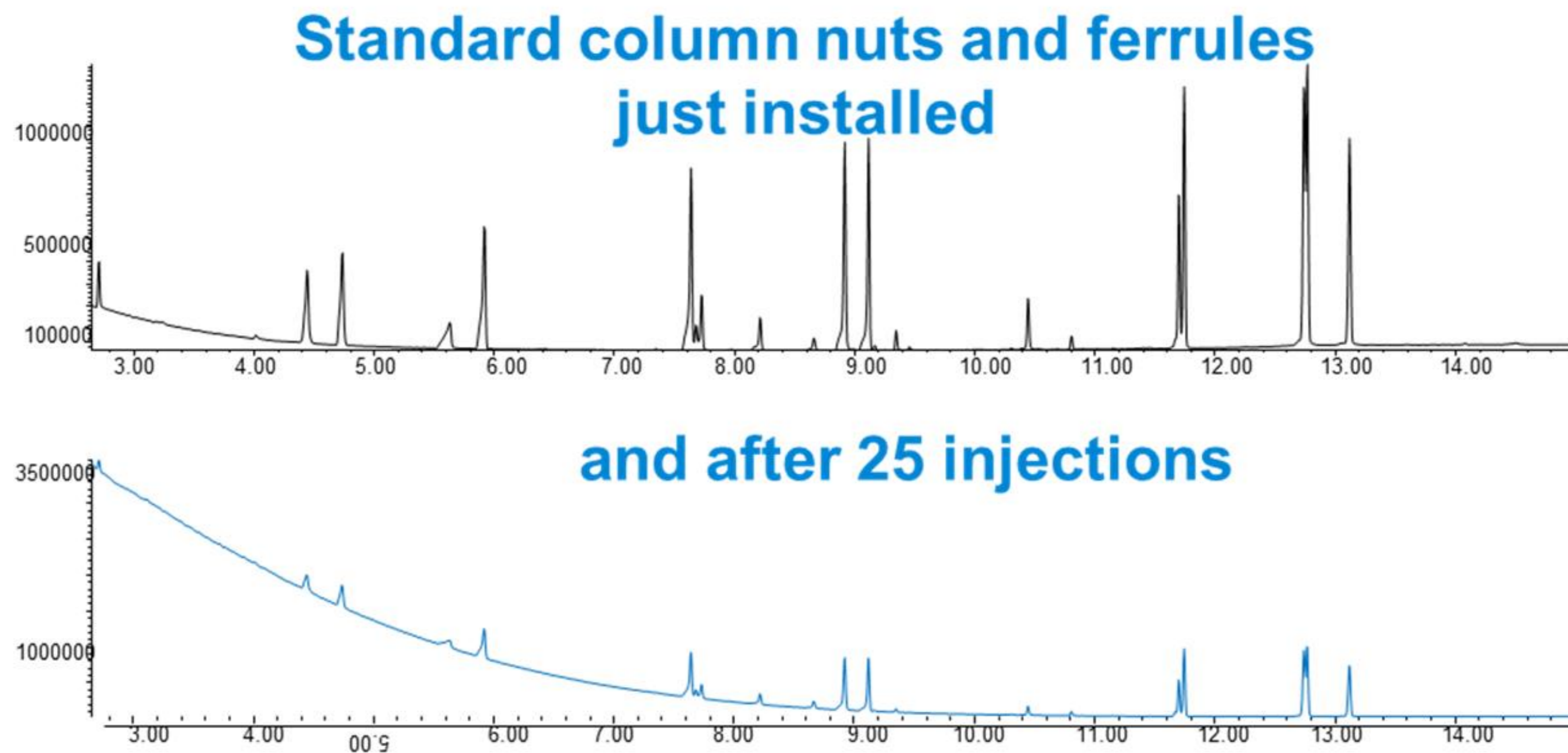

Frequent re-tightening of the fitting is needed to maintain a leak-free seal – and system performance and productivity

Capillary column nuts

Column nuts are determined by the instrument fitting

Basic mechanical fittings with little enhancements

- Brass for the MS
- Some finger tight designs for ease of use

New design addresses ease of use and productivity issues of leaking and over tightening

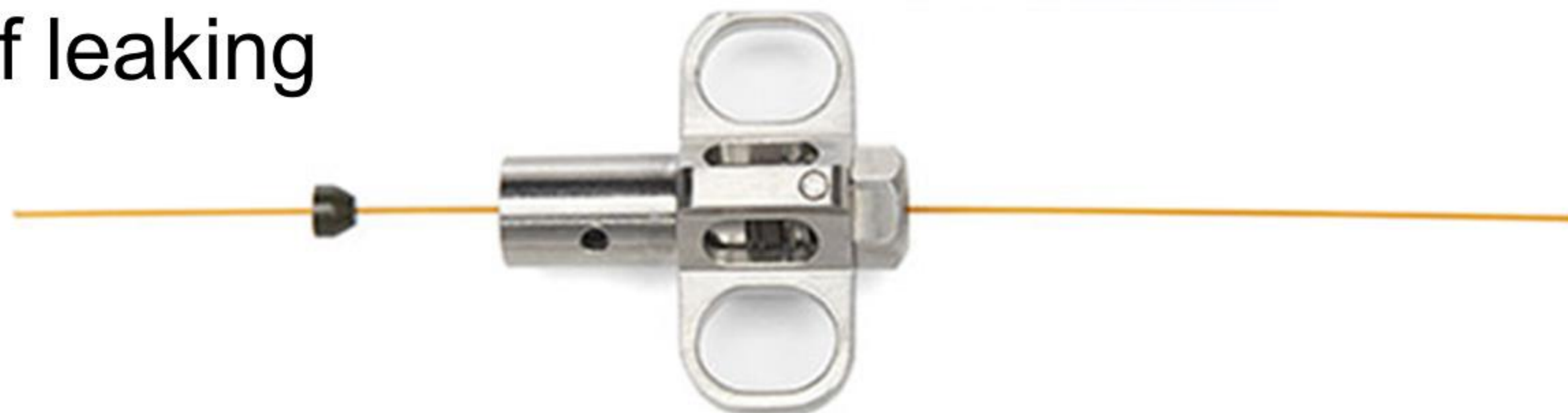

Better Connections: Self Tightening Column Nuts

Designed for use with *short* graphite/polyimide blend ferrules –both at the inlet and the MS interface – so only one type of ferrule needed for both ends of the column!



For inlet or detector



For mass spec transfer line

Short ferrule exposes more thread of the fitting for better sealing

How do Self Tightening Column Nuts work?

- Ease of use – install in dark, small space in GC oven without wrenches
- Wing design for finger tight installation with graphite/polyimide blend ferrules
- No tools dramatically reduces force preventing over tightening or damage
- Robust stainless steel construction

Plus....

- Novel **spring driven piston** design that continuously presses against the ferrule to **maintain a leak-free fitting** even when the ferrule shrinks during temperature program!



Benefit of Self-Tightening Column Nuts

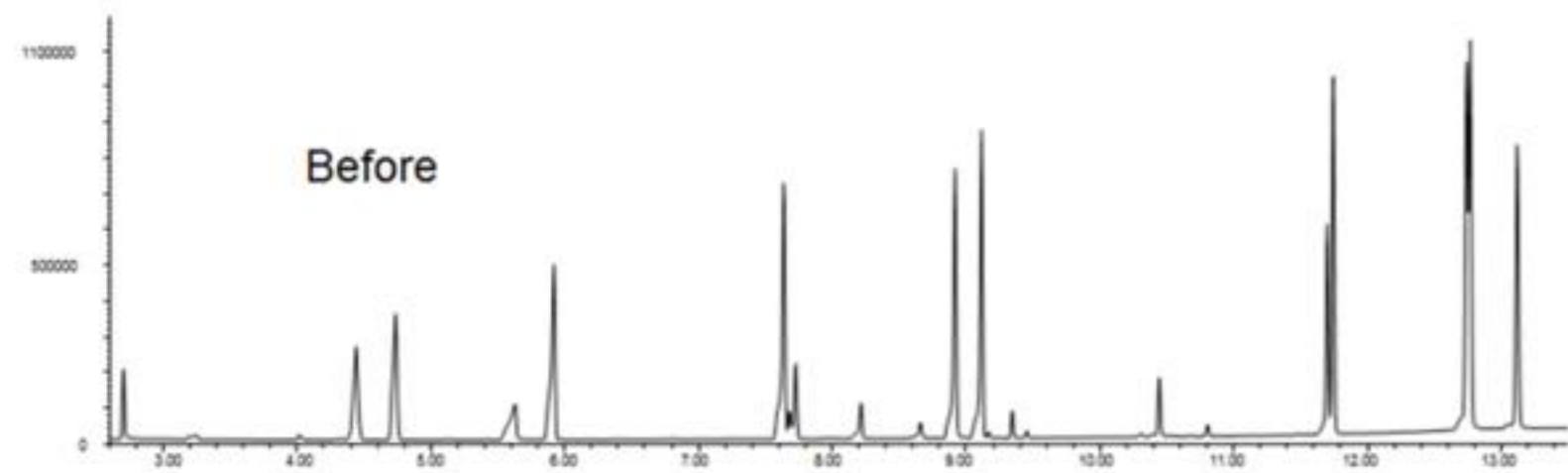

Take you from this....

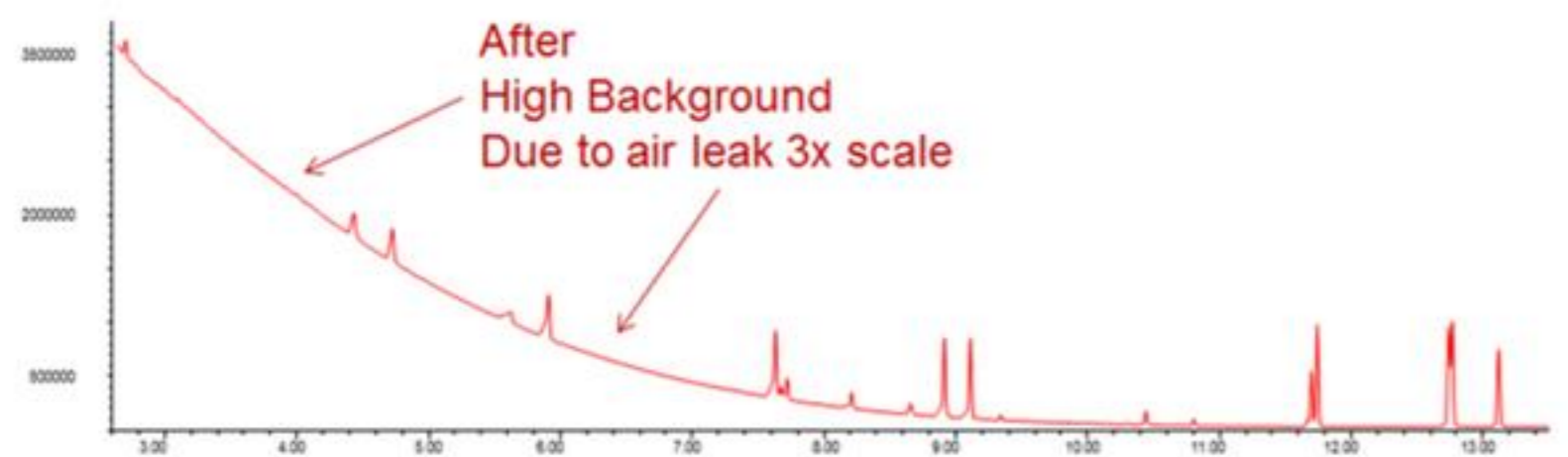

.... to this!

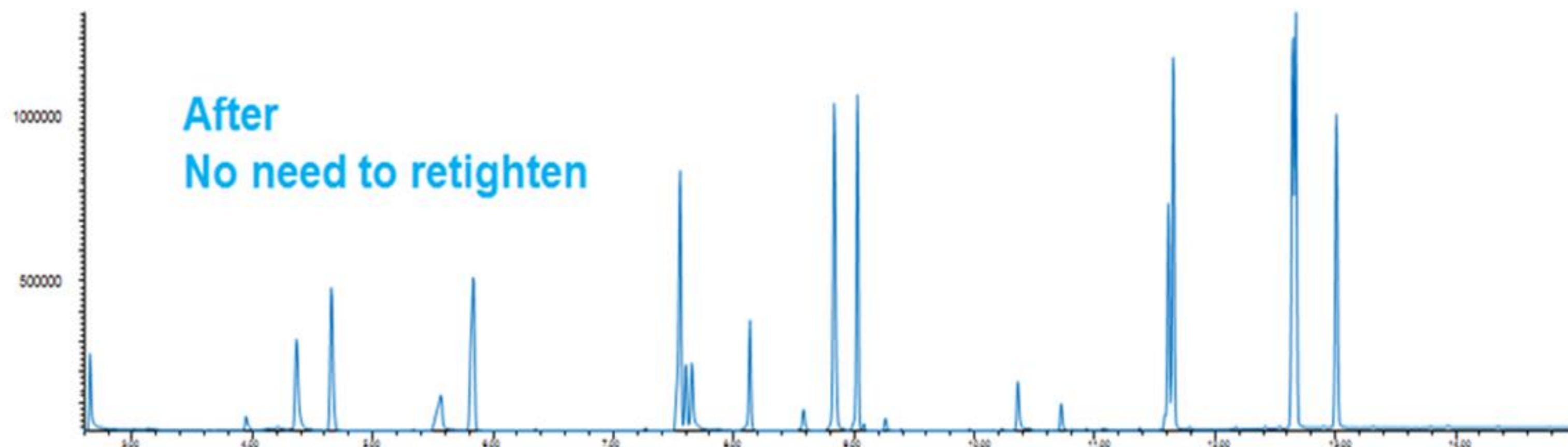
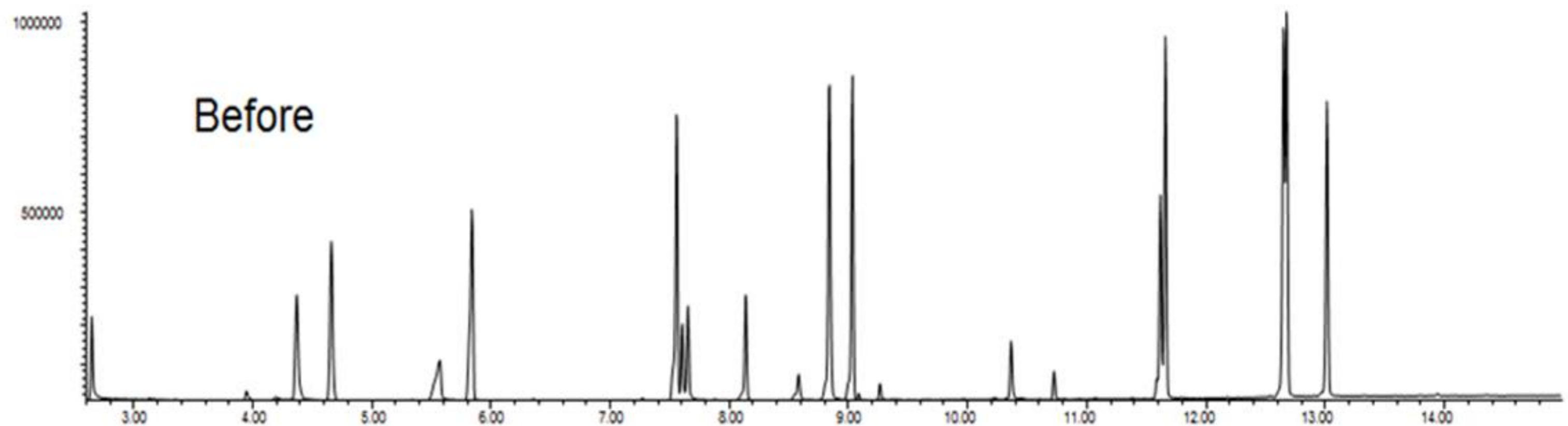

Without retightening, the baseline remains flat after 400 runs with no indication of leaks when using the Self tightening Column Nut

Ref. Tech note: 5991-3612EN

How do you make better GC column connections?

1. Start with the right tools and supplies

- Choice of right ferrules = short graphite/polyimide
- Column nuts = Self Tightening



2. Proper assembly process

- Make a good clean column cut – every time
- After the ferrule is installed
- Fused silica tubing cutters: ceramic
- Magnifier to inspect the cut - cracked fused silica and flaps of polyimide are active sites that ruin chromatography

3. Ensure the proper and consistent length of column into the fitting

Column installation assembly process

1. Thread through an inlet septum
2. Pass column through the column nut
3. Install ferrule onto the column tubing
4. **THEN** make a fresh cut
5. Inspect the cut; repeat cut if any jagged or rough edges

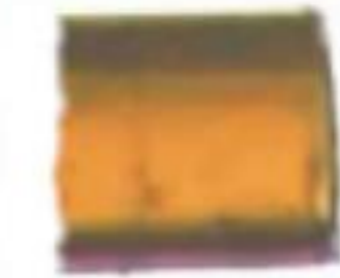
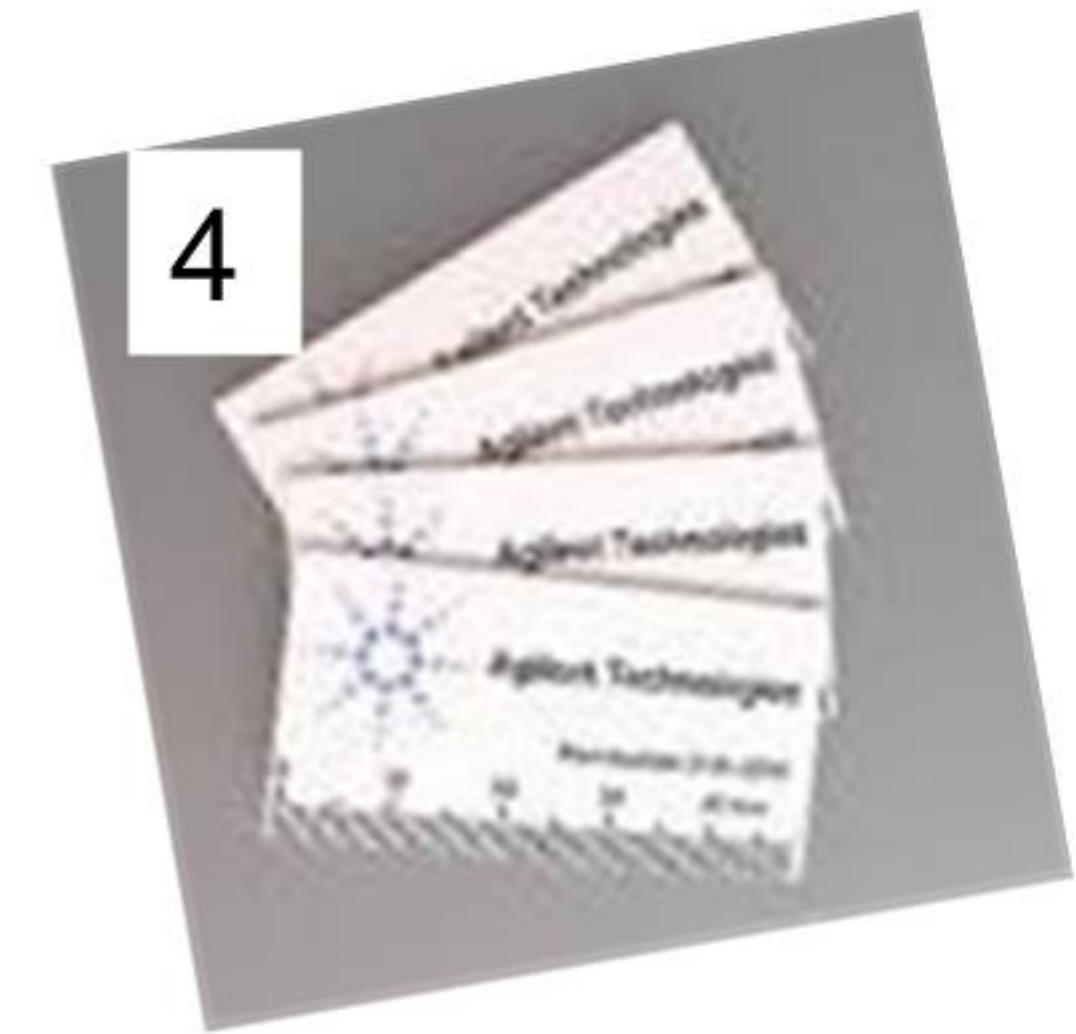
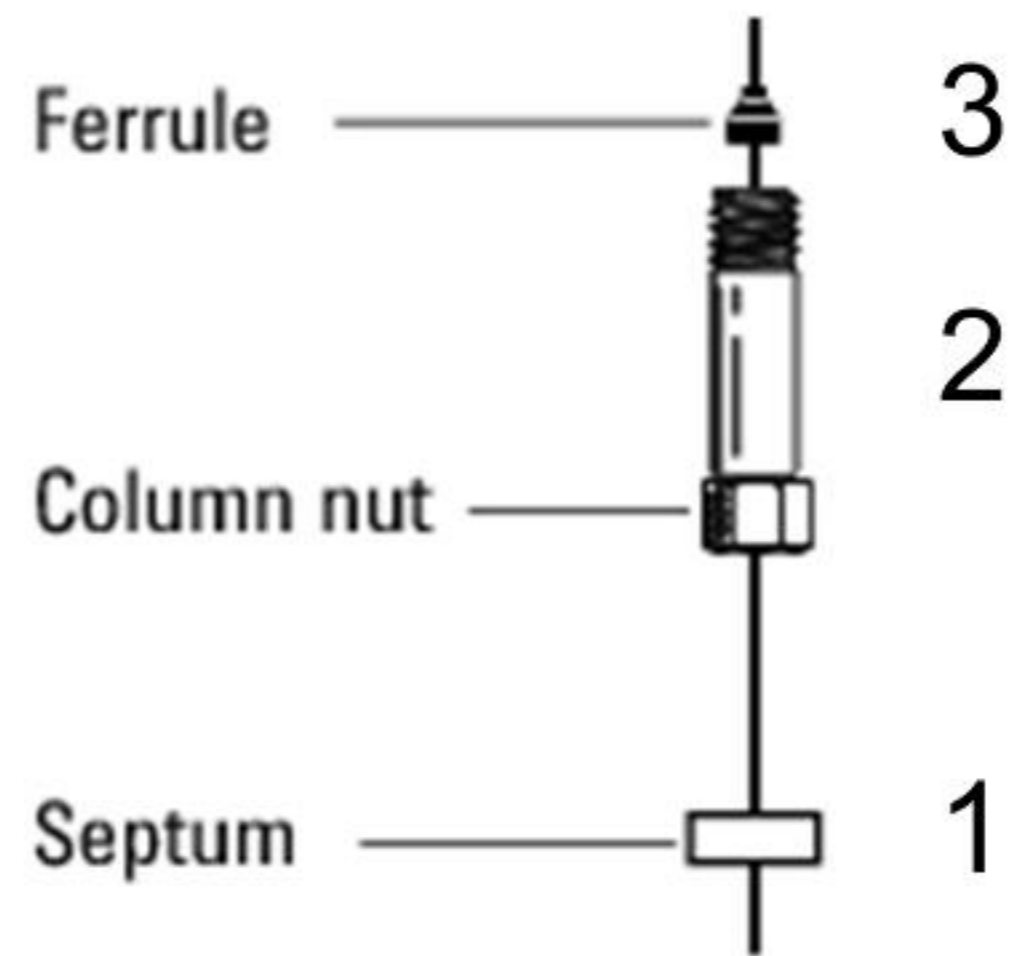

good cut



bad cut



bad cut

Ensure the proper length ... Column Installation Tools

Follow the manufacturer's recommended procedure

- Optimized GC performance and reproducibility requires ensuring the proper length of column into the fittings, every time
- Column Installation pre-swaging tools for the Split/Splitless, Multi Mode and Purge Packed Inlets available for Agilent GC models 7890/7820 and 6890/6850, for graphite or metal ferrules

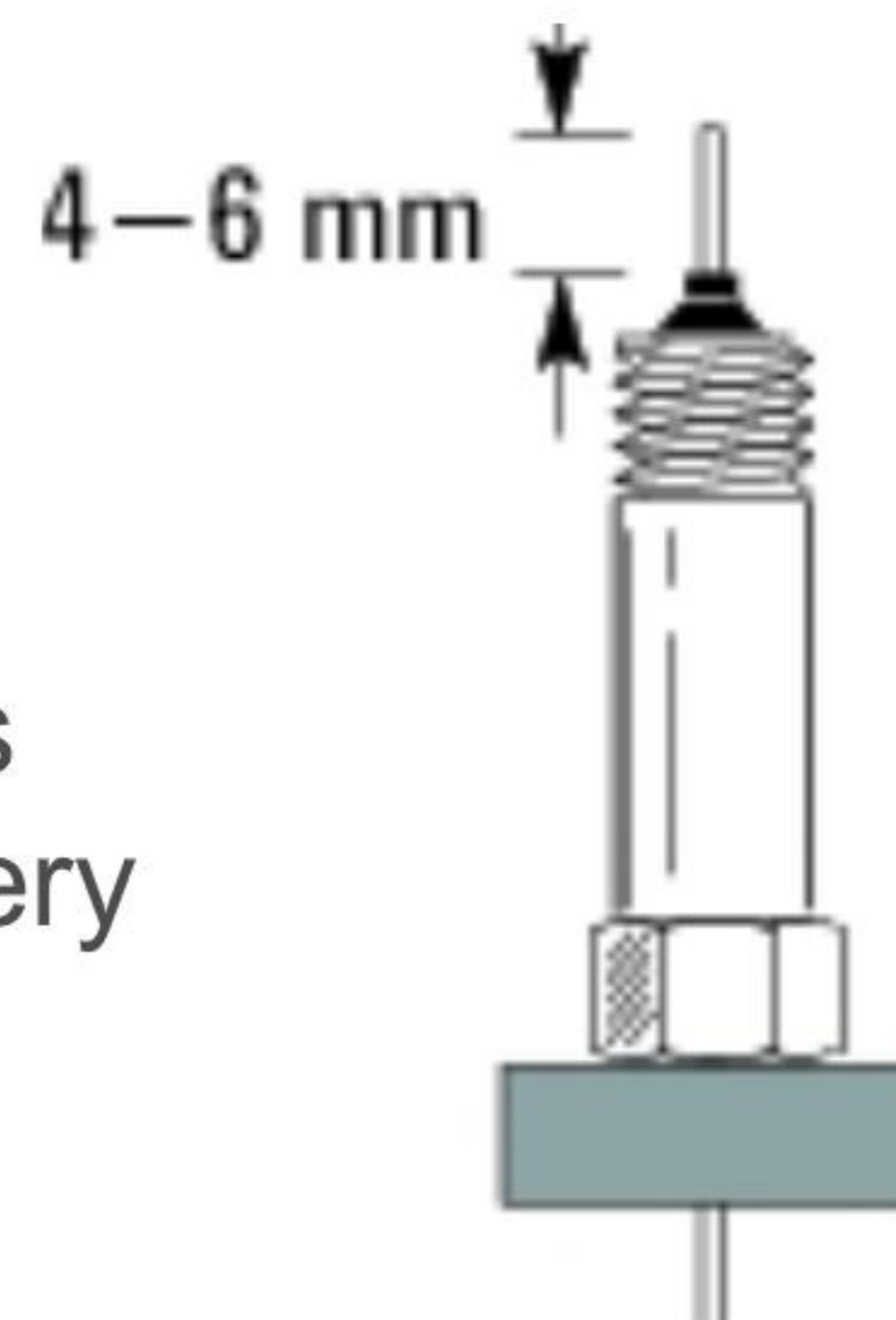

G3440-80217 Graphite Ferrules



Metal Ferrules G3440-80218



G1099-20030
MS Install Tool

Advanced techniques increase the number of connections

Simple addition of a retention gap or guard column doubles the column connections

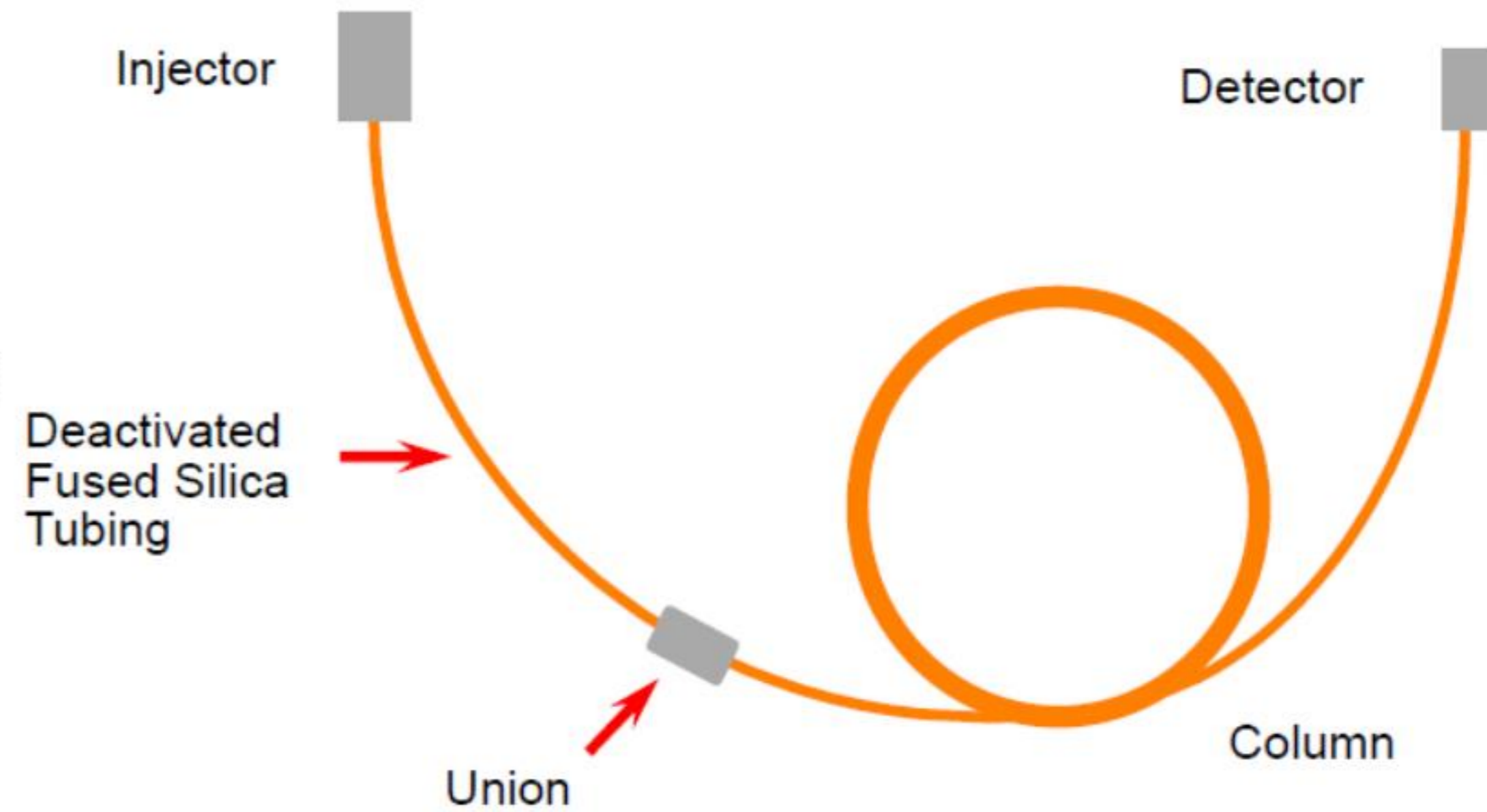

Powerful advanced GCxGC systems with many connections

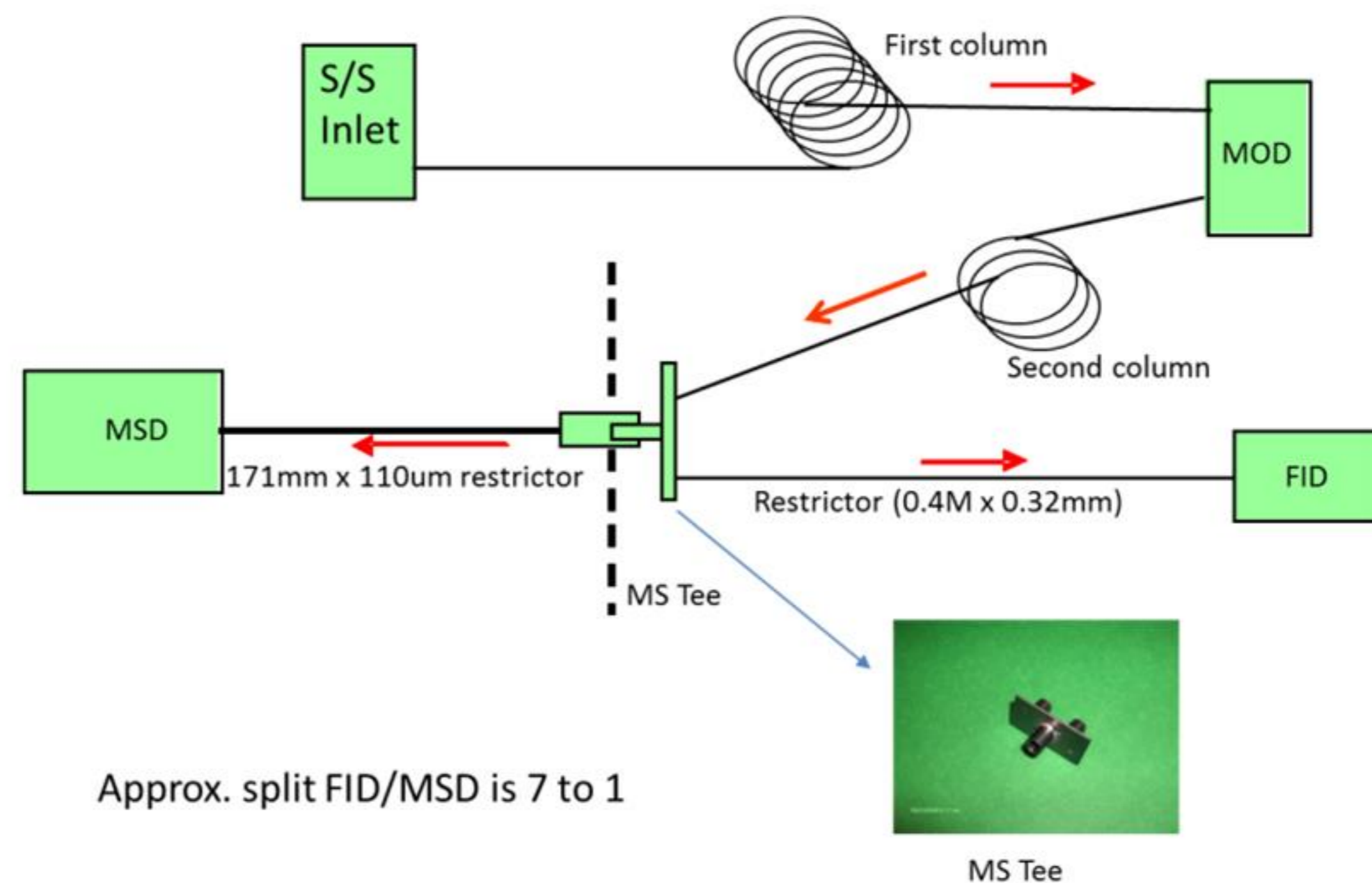

Better connections: Beyond the basics

Sample splitting for productivity:

- Split effluent from a single column to 2 or more detectors on the same GC.
- Backflush – replacing a “bakeout” for high-boiling analytes that collect in the column then interfere with subsequent analyses

GC x GC or 2-dimensional GC

- An approach used in some environmental, food and flavor, and hydrocarbon processing applications
- Separates complex mixtures using two independent columns with different stationary phase selectivity
- Columns are connected in series and separated by a modulator

Limitations to Adoption of :

All column connections must:

- be inert, not adsorbing or decomposing analytes
- have low thermal mass and low dead volume to maintain sharp peak shapes
- be leak free – and stay so
- not outgas from materials used to make the seal
- withstanding the temperatures used in the GC analysis
- not be technique dependent – must be easy to do

Blood Alcohol Analysis: The Problem with Splitters



Two holed ferrules are inexpensive and straightforward to use. Their challenges are:

1. Poor inlet dynamics
2. Unpredictable splitting
3. Requires a larger holed gold seal
4. Crowding in single taper inlet liners
5. Lack of guard column when used in the inlet

These devices resolve some of the issues but are not very popular.

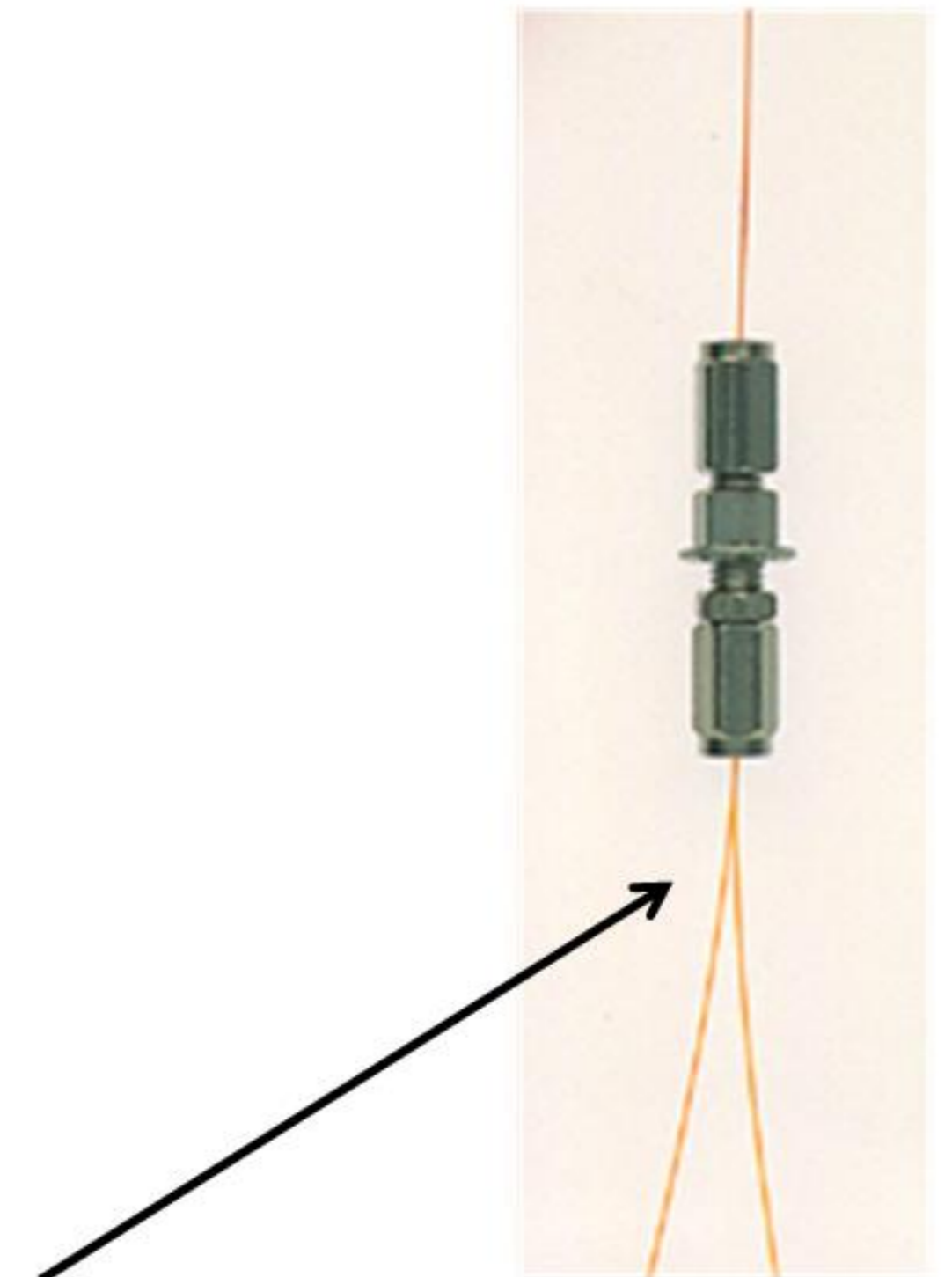

Blood Alcohol Analysis: The Problem with Splitters 2



The glass “Y” splitter overcomes many of the challenges of the 2 holed ferrule and adds expense.

However installing the connector is somewhat of an art, and even then it is prone to leaking. Unpredictably.

●Why can't I get my Press-Union connector to seal?

[Press-Union connectors](#) are easy to use, but if they are not properly sealed, they can loosen due to thermal expansion during temperature-programmed runs. The keys to successful sealing are: 1) making a clean, square cut on the column and 2) moistening the end of the column with methanol or acetonitrile before seating it into the connector. A small amount of polyimide resin also helps prevent the seal from separating during temperature cycling.

Not easy!



Better Connections: Glass column connectors

Ultra Inert Press Fits

Join retention gap or guard column to analytical, or split effluent

Dependable inertness performance at a lower cost

Improved robustness, holding strength

Batch certified inertness

Improved packaging and installation instructions

Easier to use - transparent deactivation gives visibility of the column connection



Traditional Deactivated Connector



Ultra Inert Press Fit

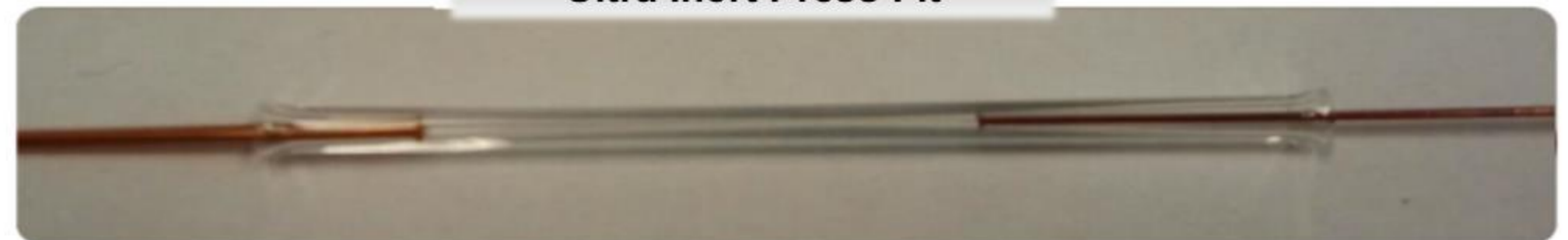

Blood Alcohol Application: Agilent Solution

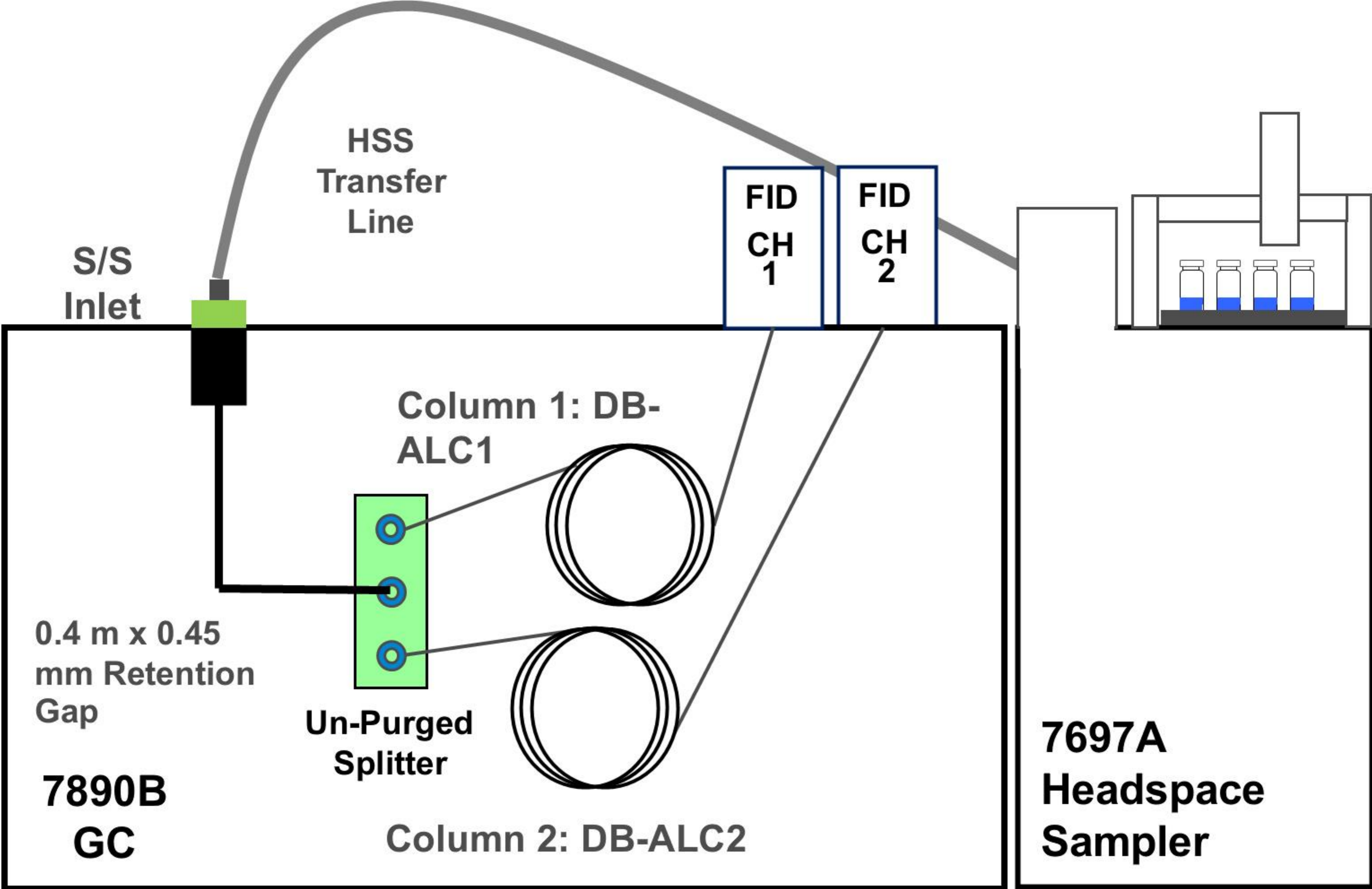

G3445B#683

Better Connections: Capillary Flow Technology Devices

UltiMetal Plus Ultimate Union/UltiMetal Plus Tee

- Stainless Steel Micro Fluidic plates technology
- Deactivation essential to block active sites
- Column connection easy to assemble Release hole for stuck ferrules



Using Flexible Metal ferrules to overcome issues

- UltiMetal Plus surface chemistry prevents activity
- Flexible design reduces risk of over tightening or column breaks
- Leak free seal remains after repeated temperature cycles



Ferrules



Vespel



Vespel/graphite



Graphite



Siltite

Composition	Re-use	Max T	Use	Limitation
Vespel	yes	280	Easy seal	Leaks after T cycle, iso only
Vespel/graphite	limited	350	MS	Retighten after T cycle
Graphite	yes	450	Not MS	Contamination, leakages
Siltite	yes	450	MS, CFT	Column breakage



“Short” ferrules for detector and inlet configurations on Agilent GC’s, provide a robust seal.



“Long” ferrules for MS transfer lines and MS interface nut



Dial packaging

Flexi-Metal Ferrules: Touchless Dial Packaging

- Easy column insertion
- No lost ferrules
- No contamination risks

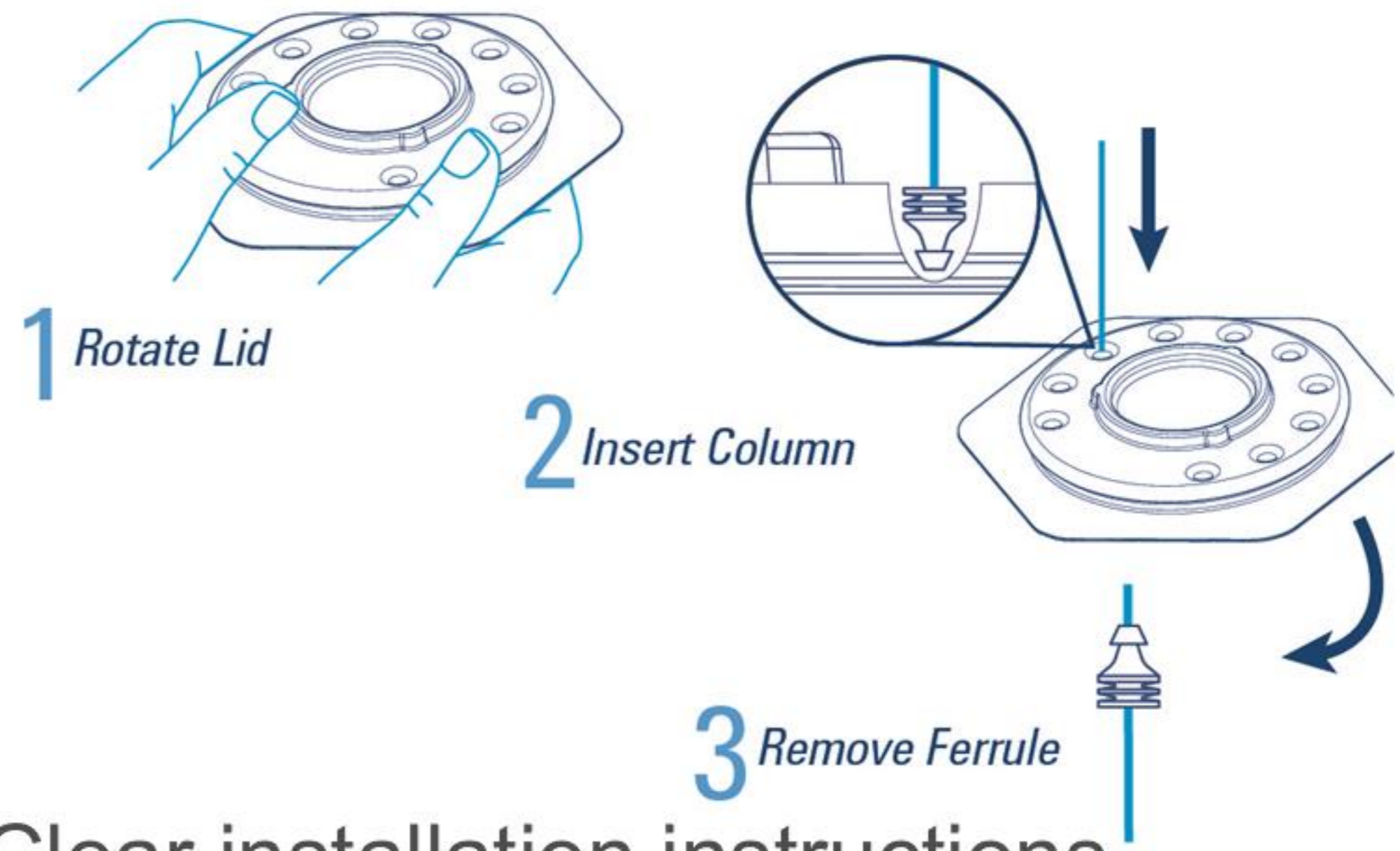

Metal (Siltite) Ferrules in Agilent Systems

- Fastest growing family of GC ferrules
- Connections with Capillary Flow Technique devices
- Secure leak free connections LTM columns
- **We experience high failure rate due to non-fitting ferrules for LTM (Low Thermal Mass modules)**

Computer aided theoretical modeling of Siltite design

- *Design flaw identified*
- *ID spec and tolerance recommendations made to supplier but was considered too costly*

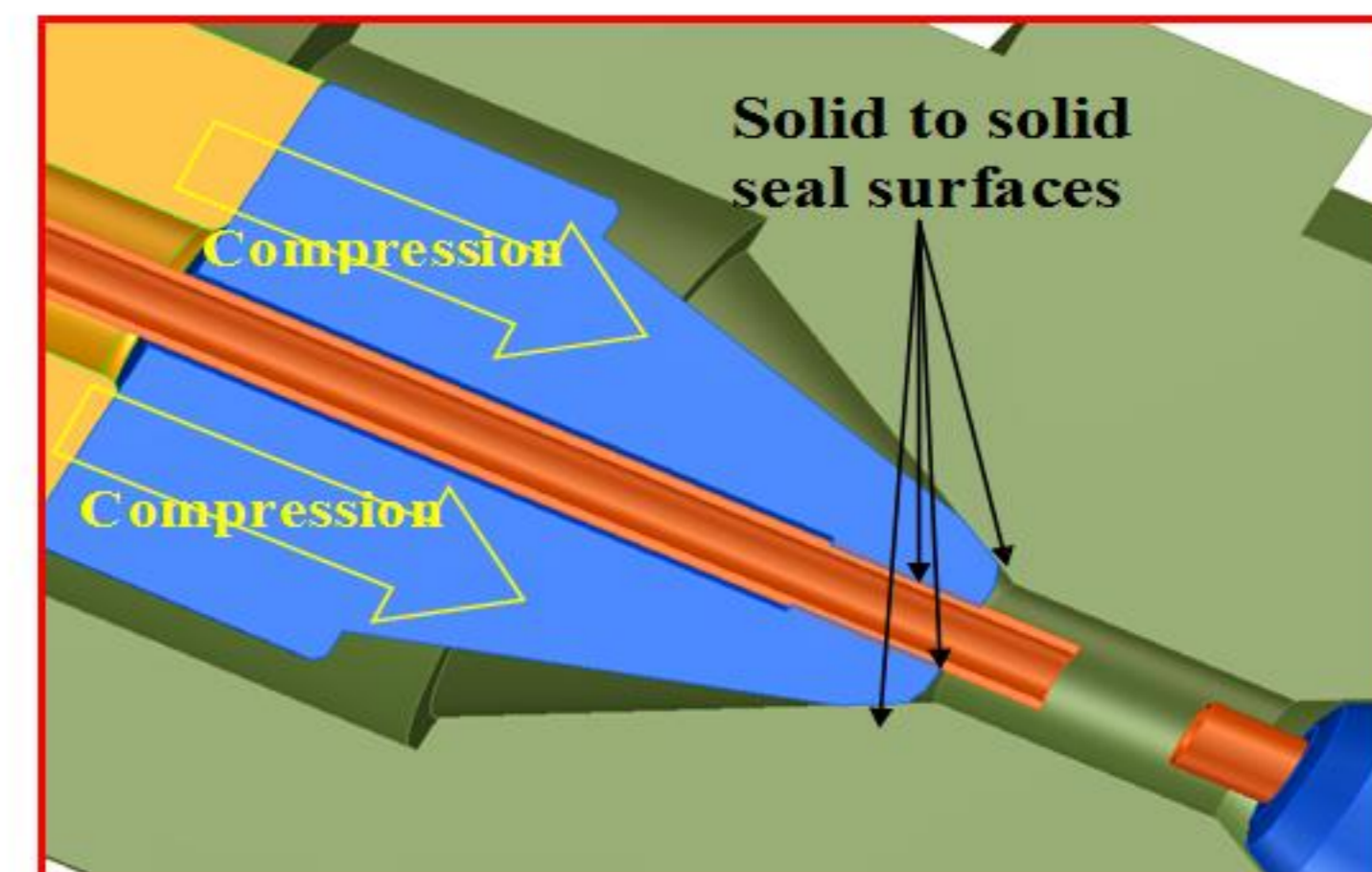

Current Ferrule

Stiff, prone to cause
**damage to column
or fitting**

Small ID compression
(40 to 60um) – **leaks**
Tolerances poorly
controlled

Quality issues

- mixed inventory
- not-fitting
- column crushing
- leaking

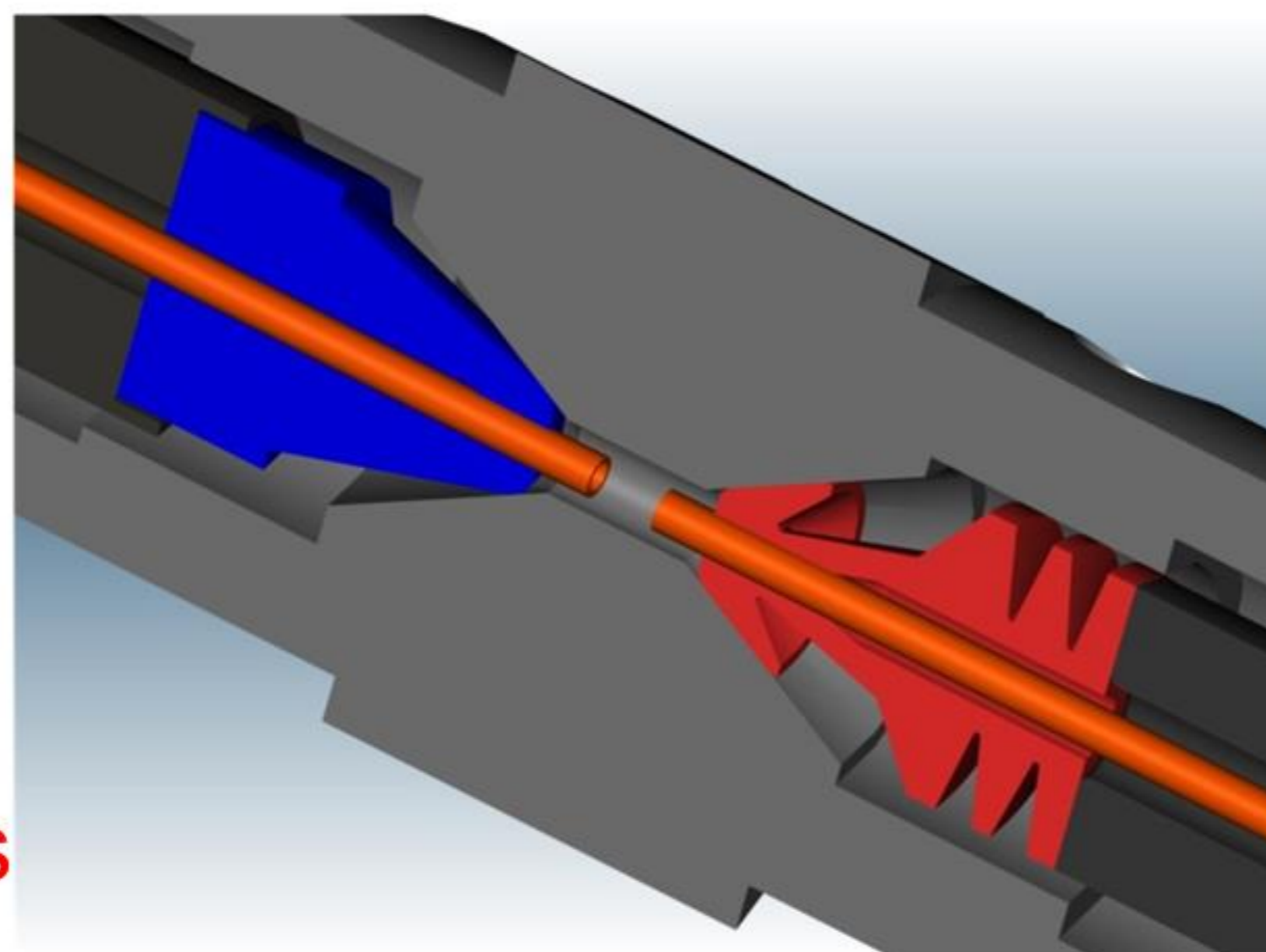

Agilent Flexi-Metal Ferrule

Computer aided Design
Finite Element Analysis

More flexible

Less column damage

Large range of
ID compression
(100 to 120um) – less leaks
Agilent design alleviates current
quality issues

More Added Value

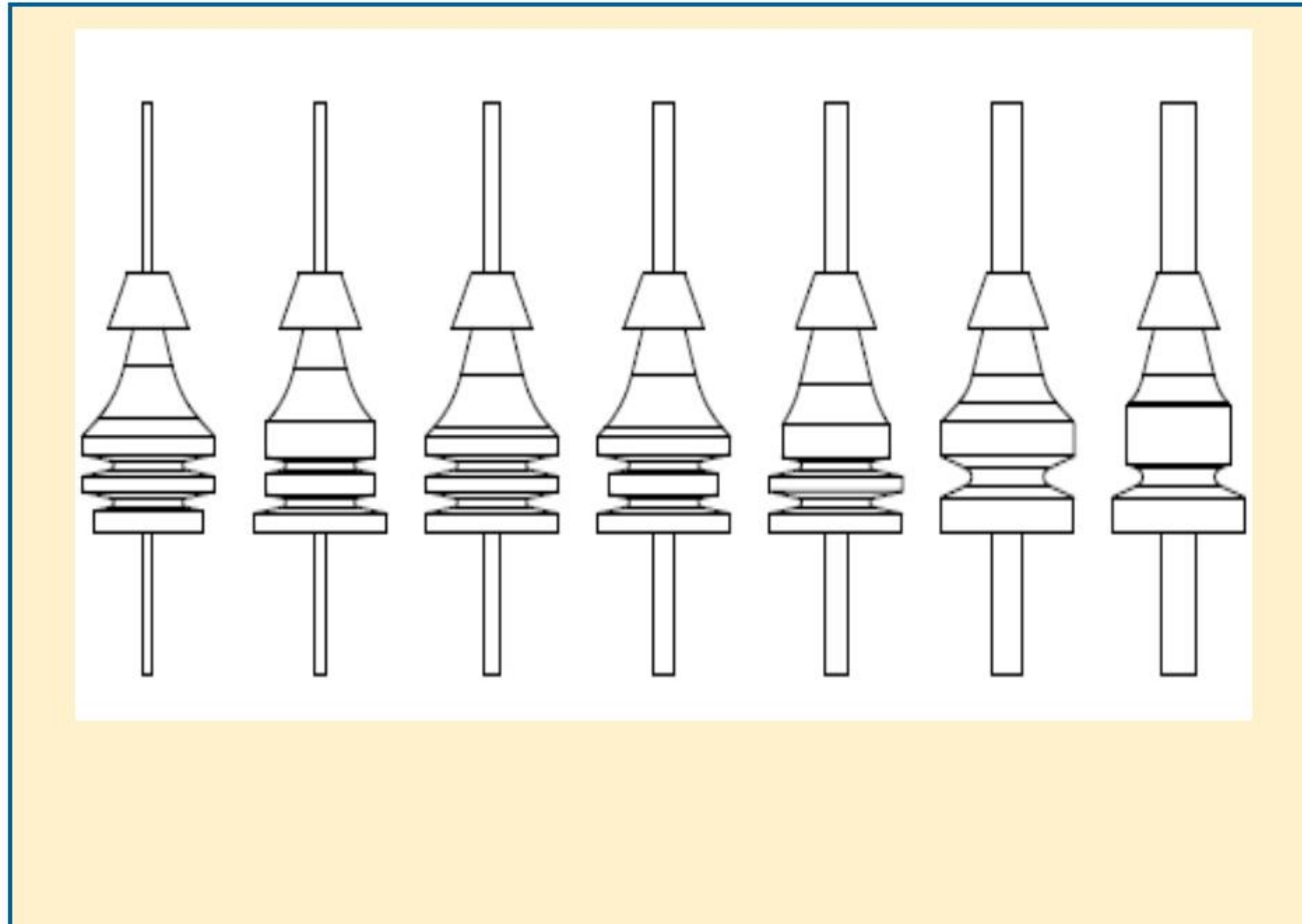

Family of ferrules for range columns
Folsom and Middelburg including
UltiMetal columns, and a no hole plug

New UltiMetal Plus surface treatment
provides excellent ferrule inertness
exceeding Siltite performance

Each ID has its own unique design
Ease of recognition, no mix-ups

Agilent Intellectual Property:
Utility patent & Design patent
applications
Exclusive Agilent product

New Touchless Dial Packaging

- Easy column insertion
- No lost ferrules
- No contamination risks

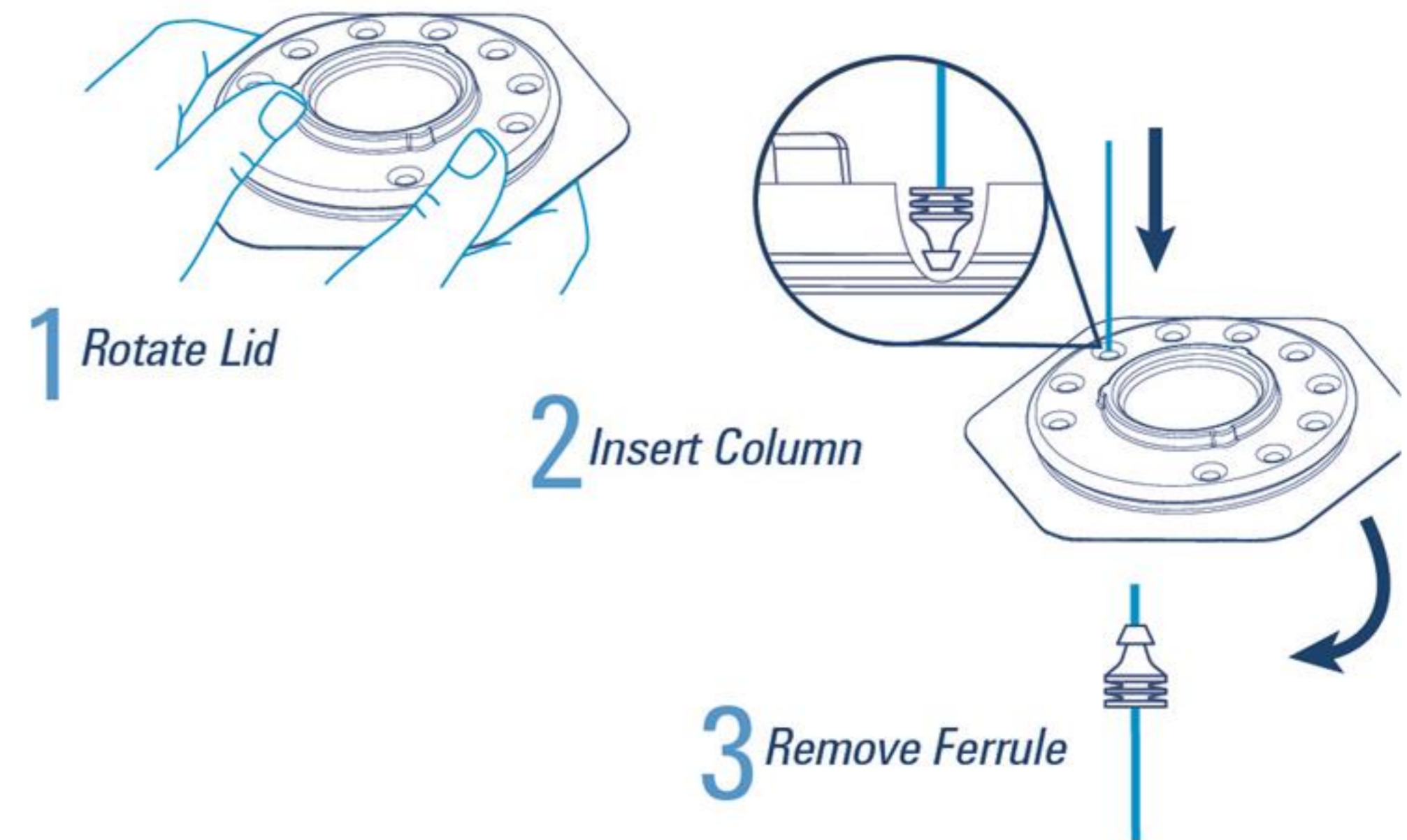

Clear installation instructions

Impact of ferrule surface on inertness

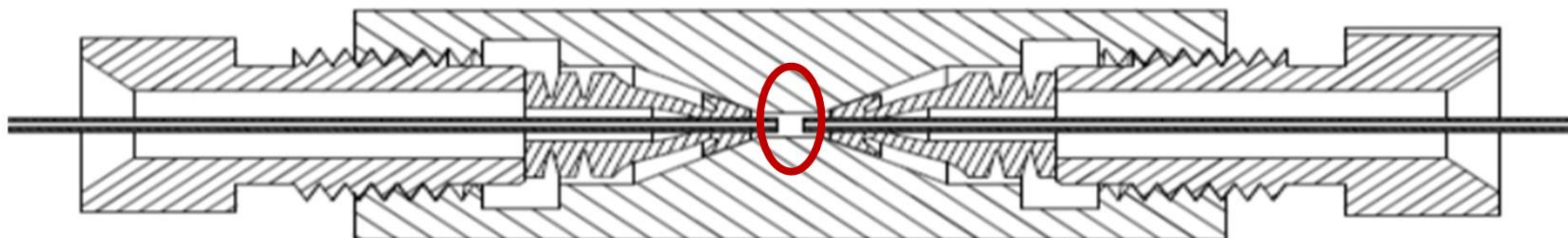

Very small amount of ferrule surface exposed to active pesticides

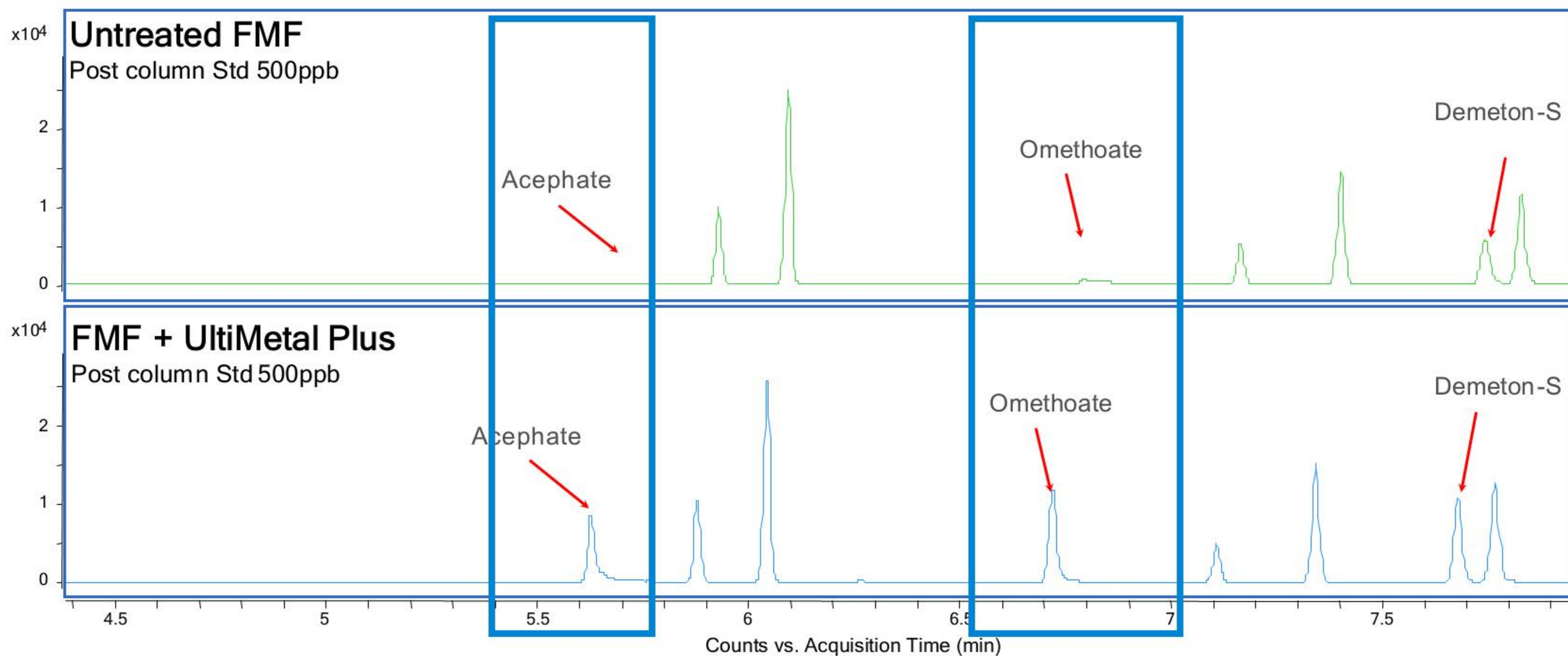

Flexible Metal Ferrules: What are Customers Saying?

“We have tested them in our facilities. Can you also give me the part numbers for the 0.5 mm and 0.8 mm as well? We are planning to implement the technology swiftly to replace the Silitite ferrules.”

Lab Director at a large chemical company



Flexible Metal Ferrules Positioning

Substitute for Siltite ferrules in

- ❑ All CFT devices
QuickSwap
Backflush
- ❑ Ultimate union
- ❑ LTM



“Long” ferrule applications

*Not optimized for regular Agilent inlet / detector connections
but possible! Graphite/vespel ferrules allow more
economical column trimming and re-tightning*

“Short” ferrules

Summary

Agilent Flexible Metal Ferrule

Family of novel, **patentable design** capillary column metal ferrules
Capillary Flow Technology fittings
Agilent GC inlets and detectors
MS interface.

- Reduces risk of over tightening and breaking column
- Leak free seal after repeated temperature cycles
- UltiMetal Plus chemistry prevents loss of active analytes

Ease of Use

- Easy assembly and tighten to give a leak free seal (“forgiving”)
- Ferrule ID identification by design
- Quick installation due to design & packaging



...and there's a video!

Agilent UI Gold Seal: Deactivated gold surface

- Soft gold plating is essential for proper sealing
- Ultra Inert chemistry blocks active sites (gold is NOT inert)
- Smooth surface doesn't leak
- Advantage Agilent

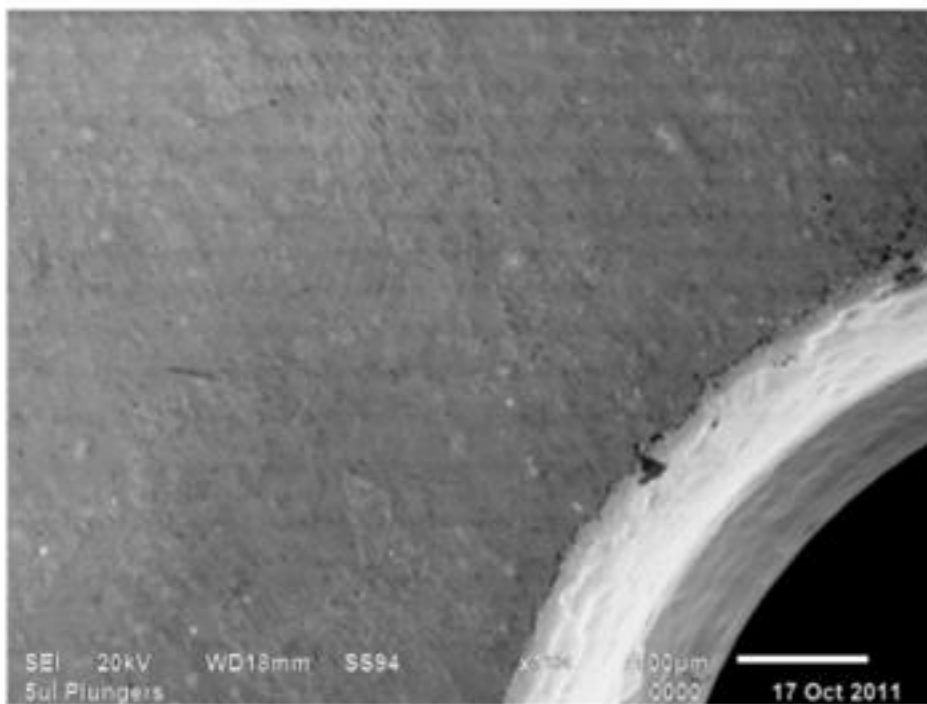

Agilent MIM seal

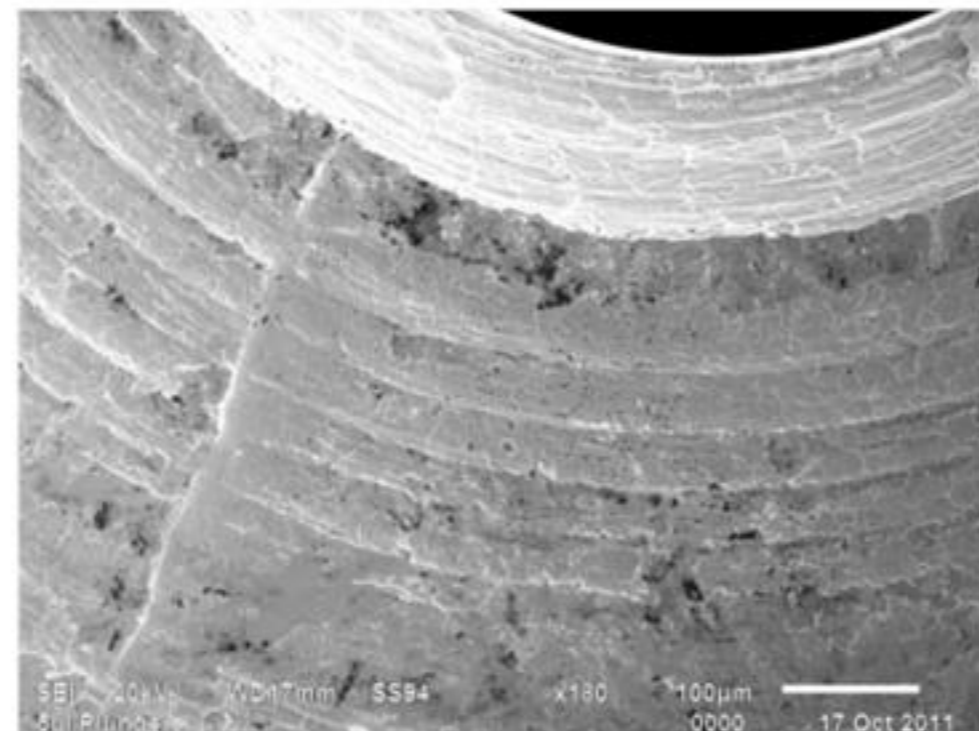

Competitor's
machined seal

*Reliable ppb and ppt
measurements require
attention to the little things!*

Better connections: UltiMetal Plus Tubing and Fittings



- UltiMetal Plus Deactivated metal tubing and valves
- 0.53 and 0.25 mm ID guards and transfer lines
- Metal fittings (unions, tee's and nuts)
- Steel tubing (1/16", 1/8", 1/4")
- UltiMetal Plus fused silica guard columns



Ensure the entire chromatographic solution is inert and corrosion resistant to provide superior performance with improved peak shapes even for active compounds

Making Better GC Connections

- Select supplies appropriate for your instrument and application
- Follow recommended assembly process
- Maximize productivity by using innovative tools and supplies
 - Column Installation Pre-swaging Tools
 - Self Tightening Column Nuts
 - Ultra Inert Press Fit Connectors
 - UltiMetal Plus Flexible Metal Ferrules
 - UltiMetal Plus Tubing and Fittings



Agilent Inert Flow Solution

Ultimetal Plus Inlet Weldment, Shell and Transfer Lines



Ultra Inert Inlet Liner



Ultimetal Plus Ferrules



Ultimetal Capillary Flow Technology Devices, Ultimate Union

Ultimetal Plus– TCD, FPD, NPD/FID Jets
Inert MS Source

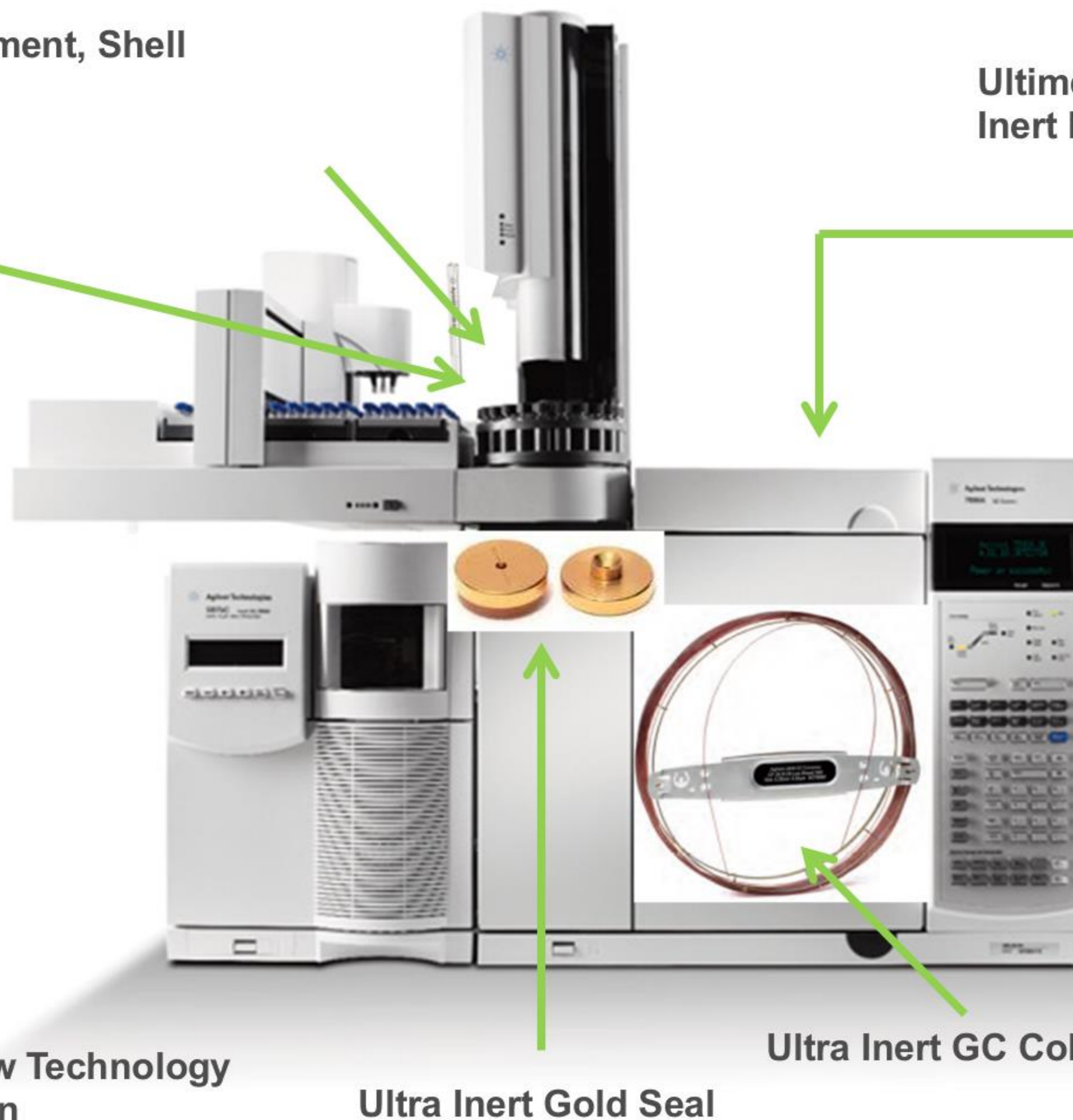
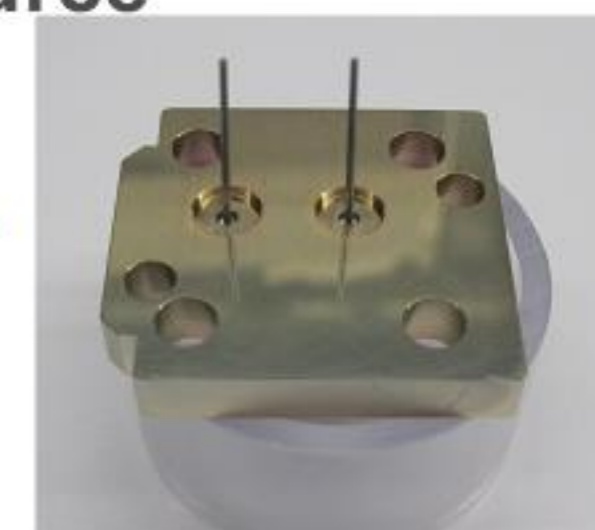

Ultra Inert Gold Seal

Ultra Inert GC Column



Agilent Technologies

Putting It All Together — Agilent Inert Flowpath

Dramatic Improvement at Low Levels

Drugs of Abuse 0.25 ng Column SIM Mode

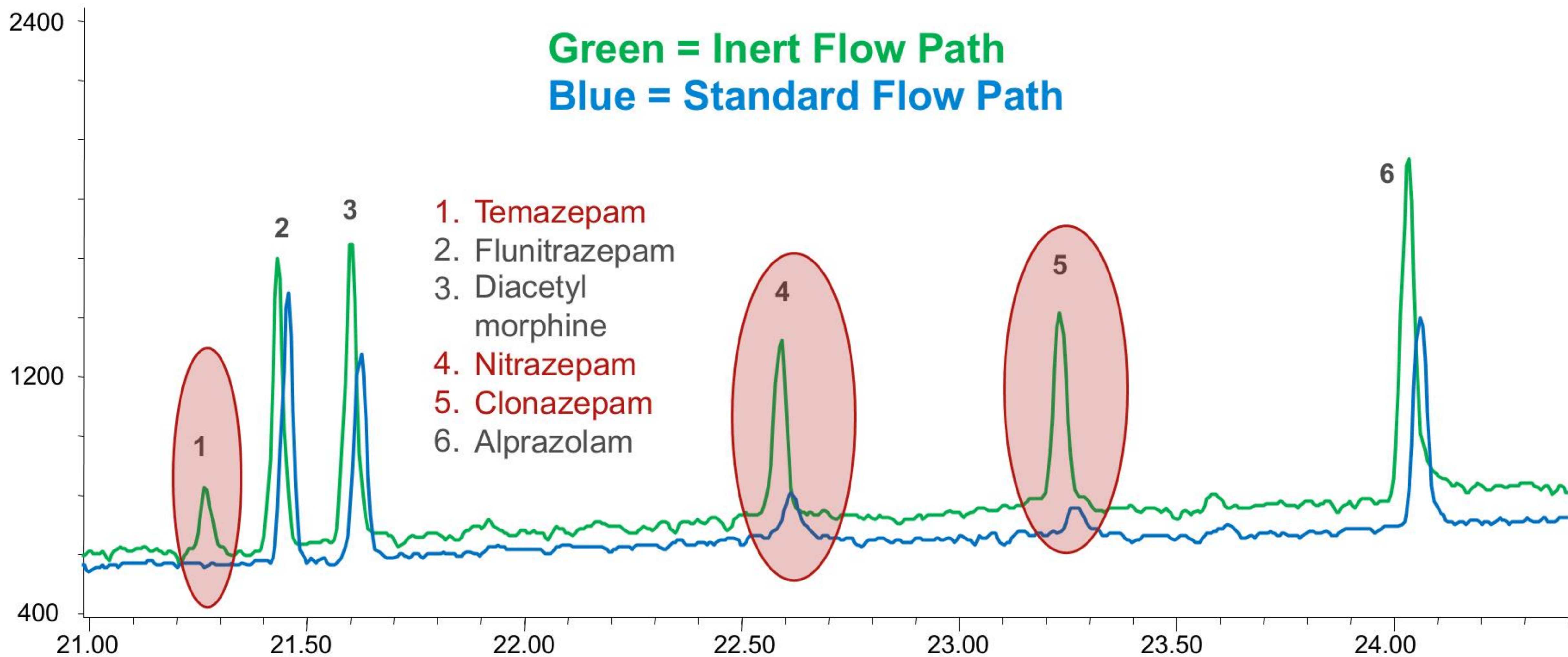

NOW IT'S EASIER THAN EVER TO GET RELIABLE GC RESULTS THROUGH BETTER GC CONNECTIONS FROM AGILENT

www.agilent.com/chem/betterGCconnections

Order the poster...

View the video...

SIX TIPS FOR TIGHTER GC CONNECTIONS AND BETTER RESULTS

Inspecting your GC column connections is a key part of good preventive maintenance – and a laboratory practice that you simply cannot afford to overlook. That's because poor, leaky connections can cause:

- Noisy baselines
- Loss of expensive, high-quality gas
- Shorter column and detector life
- Decreased system sensitivity
- Reduced system productivity

This poster highlights the critical GC connection "hotspots" to help you fix problems before they compromise your results.

The Majesty of Excellence

Keep in mind that other factors affect the quality and consistency of your data.

1. Inspect the ferrule and nut for wear and tear. The ferrule should be replaced if it is worn or damaged. The nut should be replaced if it is worn or damaged.
2. Inspect the ferrule and nut for wear and tear. The ferrule should be replaced if it is worn or damaged. The nut should be replaced if it is worn or damaged.
3. Inspect the ferrule and nut for wear and tear. The ferrule should be replaced if it is worn or damaged. The nut should be replaced if it is worn or damaged.
4. Inspect the ferrule and nut for wear and tear. The ferrule should be replaced if it is worn or damaged. The nut should be replaced if it is worn or damaged.
5. Inspect the ferrule and nut for wear and tear. The ferrule should be replaced if it is worn or damaged. The nut should be replaced if it is worn or damaged.
6. Inspect the ferrule and nut for wear and tear. The ferrule should be replaced if it is worn or damaged. The nut should be replaced if it is worn or damaged.

To learn more about creating and maintaining leak-free GC connections, go to www.agilent.com/chem/betterGCconnections

Agilent Technologies

Better_CG_Connections_08c-FINAL_1280x720

Agilent Technologies
Part Number 5181-8930

Agilent Self Tightening Column Nut with short graphite polyimide blend ferrule

00:52

QUESTIONS

