

Understanding the Inlets

How to Choose the
Right One!

Abby Folk
Application Engineer
Agilent Technologies, Inc.
October 2, 2013

Types of Inlets

Purged Packed

Split / Splitless

Agilent Inert Flow Path Solutions!!!

Cool On Column

Programmable Temperature Vaporization

Volatiles Interface

Multi Mode Inlet

Where to Begin???

What are the requirements of the method?

Trace level analysis?

% level analysis?

High temperature application?

Packed column??

What do you know about the sample?

Dirty or clean?

Residual solvent?

Volatility range?

Inlet Use Guide

MMI

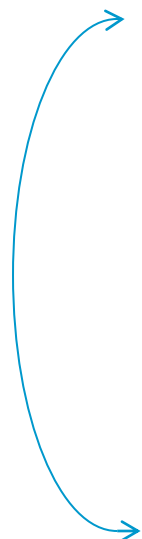

Inlet	Column	Mode	Sample concentration	Comments	Sample to column
Split/splitless	Capillary	Split	High	Useful with large injections	Very little
		Pulsed split	High		Very little
		Splitless	Low	Useful with large injections	All
		Pulsed splitless	Low		All
Cool on-column	Capillary	n/a	Low or labile	Minimal discrimination and decomposition	All
Packed column	Packed	n/a	Any	OK if resolution not critical	All
	Large capillary	n/a	Any		All
Programmed temperature vaporization	Capillary	Split	High	Multiple injections concentrate analytes and vent solvent	Very little
		Pulsed split	High		Very little
		Splitless	Low		All
		Pulsed splitless	Low		All
		Solvent vent	Low		Most
Volatiles interface (for use with external volatiles sampler)	Capillary	Direct	Low	Lowest dead volume Max flow = 100 mL/min	All
		Split	High		Very little
		Splitless	Low		All

COC Flow diagram

Cool-On-Column

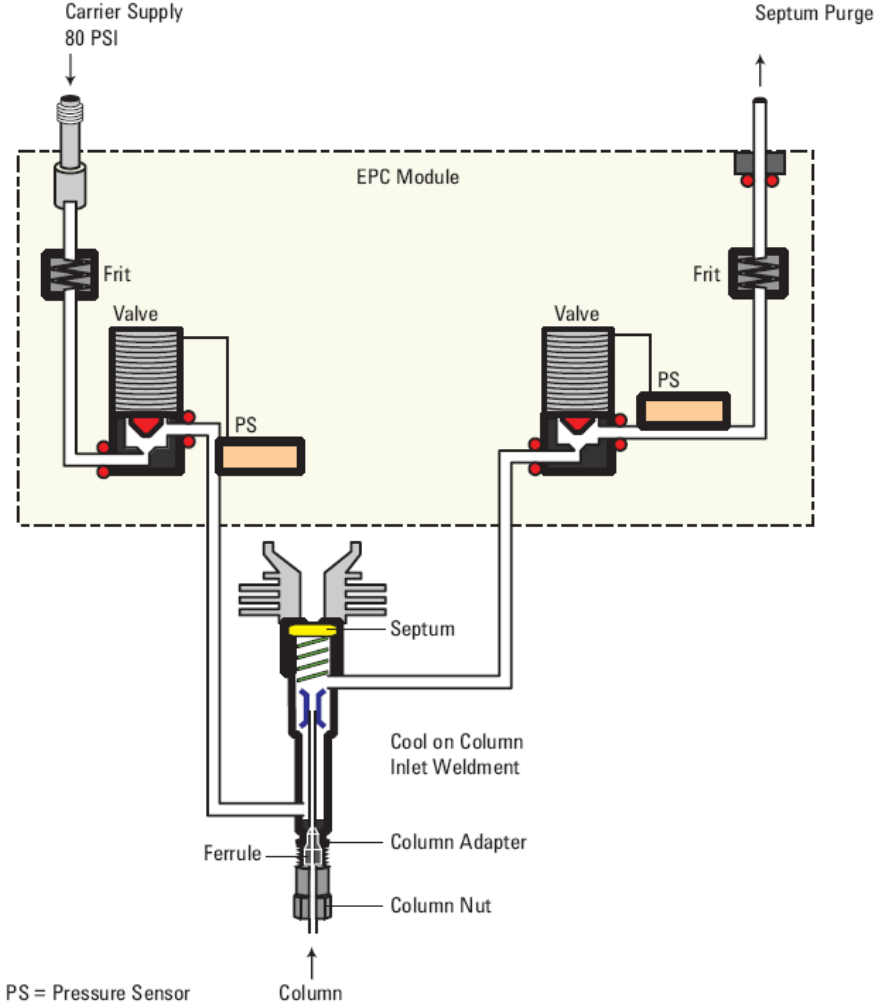

COLD ON-COLUMN INJECTION PORT

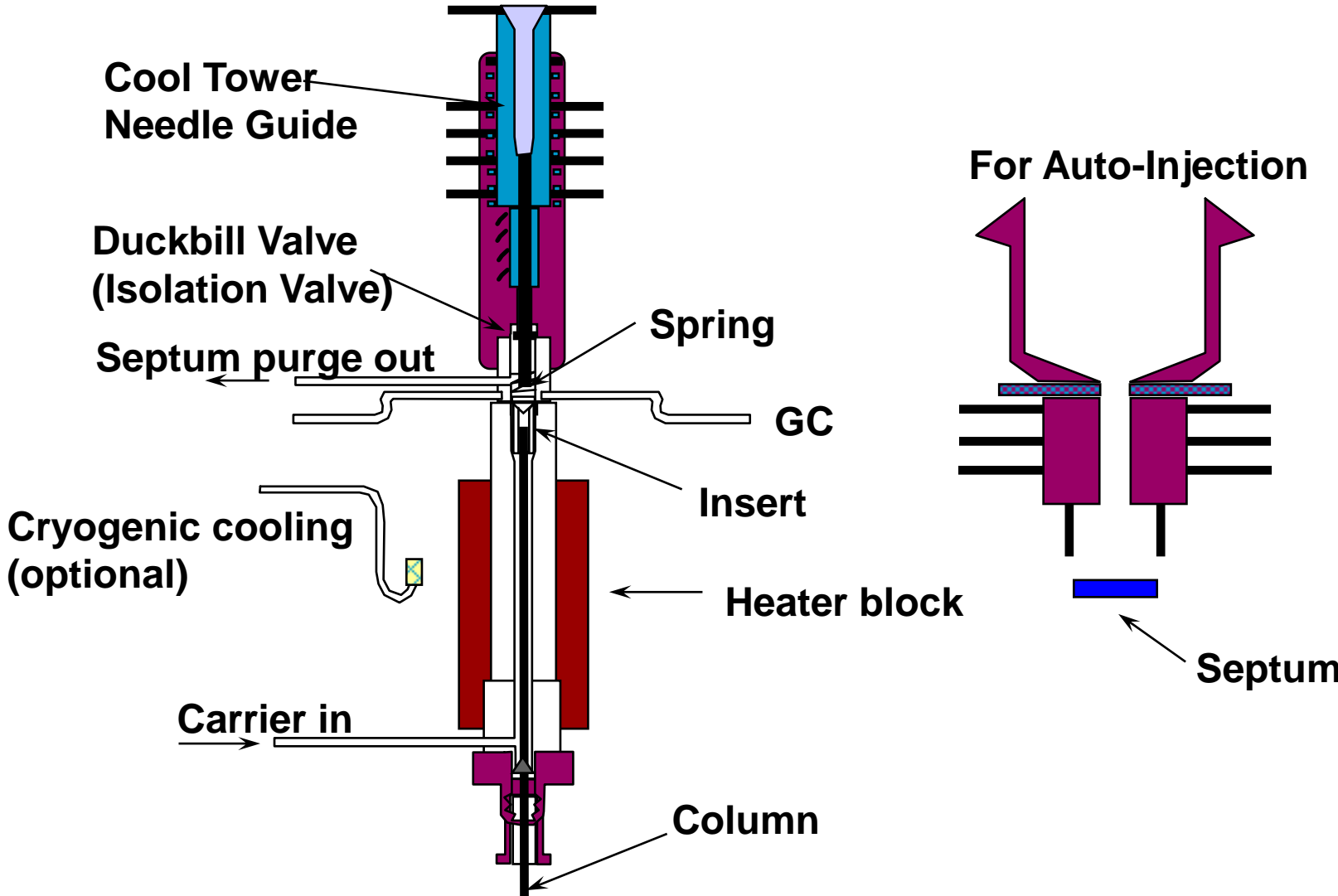

COC – Mode of Operation

Oven Track Mode

Inlet temperature stays 3°C above the oven temperature

Temperature Programmed Mode

Can program 3 temperature ramps

COC Benefits

Sample Discrimination does not occur

If operated correctly, accurate and precise results are obtained

Can be used to gauge liner activity

Very Gentle sample introduction – limits decomposition of analytes.
Good for Labile compounds!

Used for high temperature applications.

Biodiesel

COC inlet

Key parameters to be used:

- ❖ **Starting inlet temperature must be below the boiling point of the solvent being used!!!**

Guard column / Retention Gap strongly recommended to help protect the analytical column, and focus the sample

COC Troubleshooting Tips

Bent needles

- using the wrong size needle or insert
- insert has burrs

Plugged needles due to septum coring

Lost peak shape

- examine inlet end of column with a magnifier and flashlight, looking for discoloration or particles

Injection volume too large

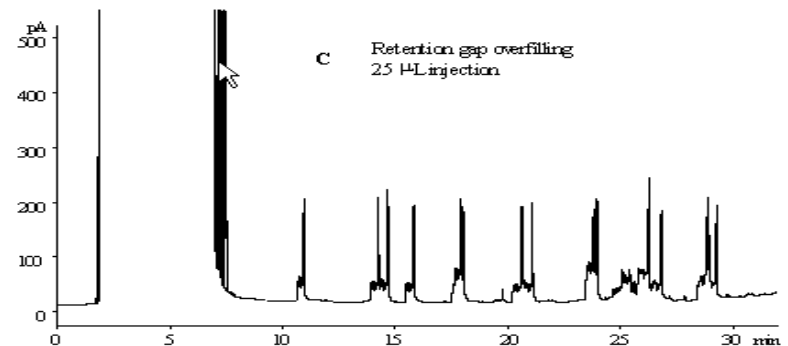

PTV Flow Diagram

Programmable Temperature Vaporization

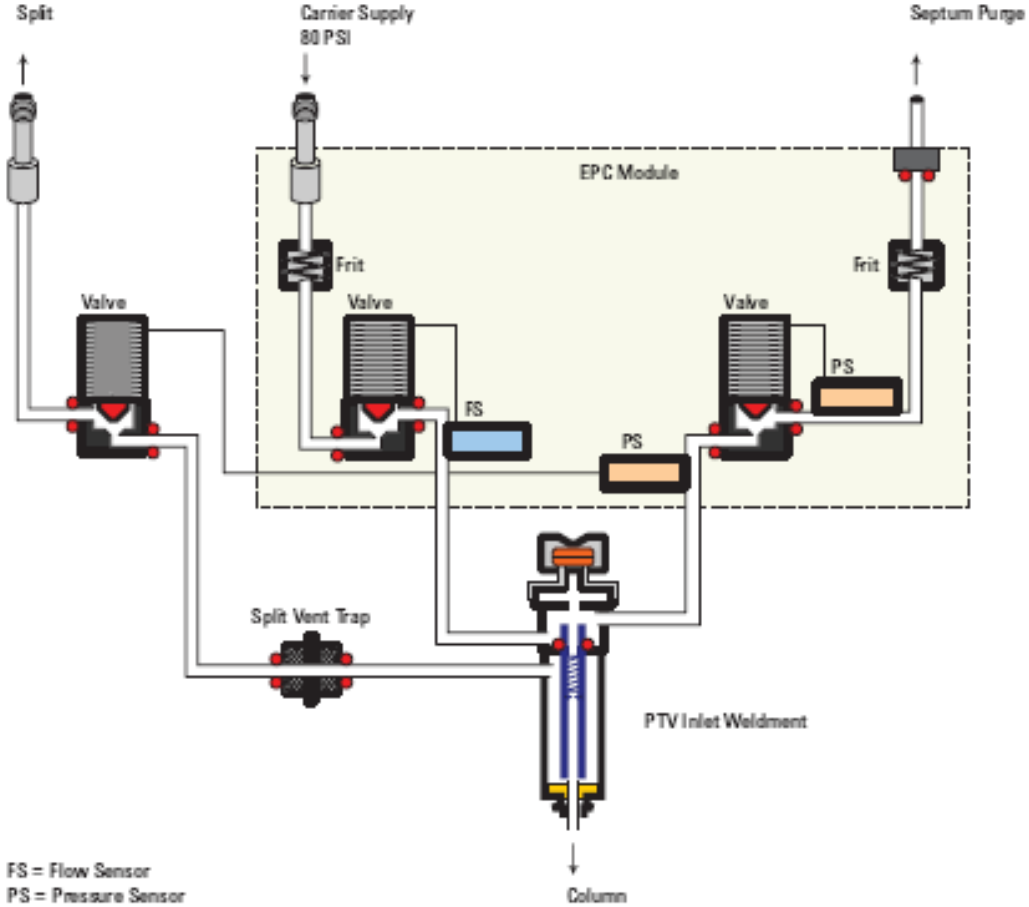

PTV modes of operation

Split	Major component analysis
Pulsed Split	Best used with low split flows
Splitless	Trace level analysis
Pulsed Splitless	More efficient sample transfer
Solvent Vent	Large Volume injections

PTV Inlet

Not good for Hot injections

Minimal inlet discrimination – closest to COC

Large volume injections

Solvent vent mode

Can eliminate volatile components of the sample

Rapid Heating and Cooling

Cold trapping of Gas Injection

Volatiles Interface

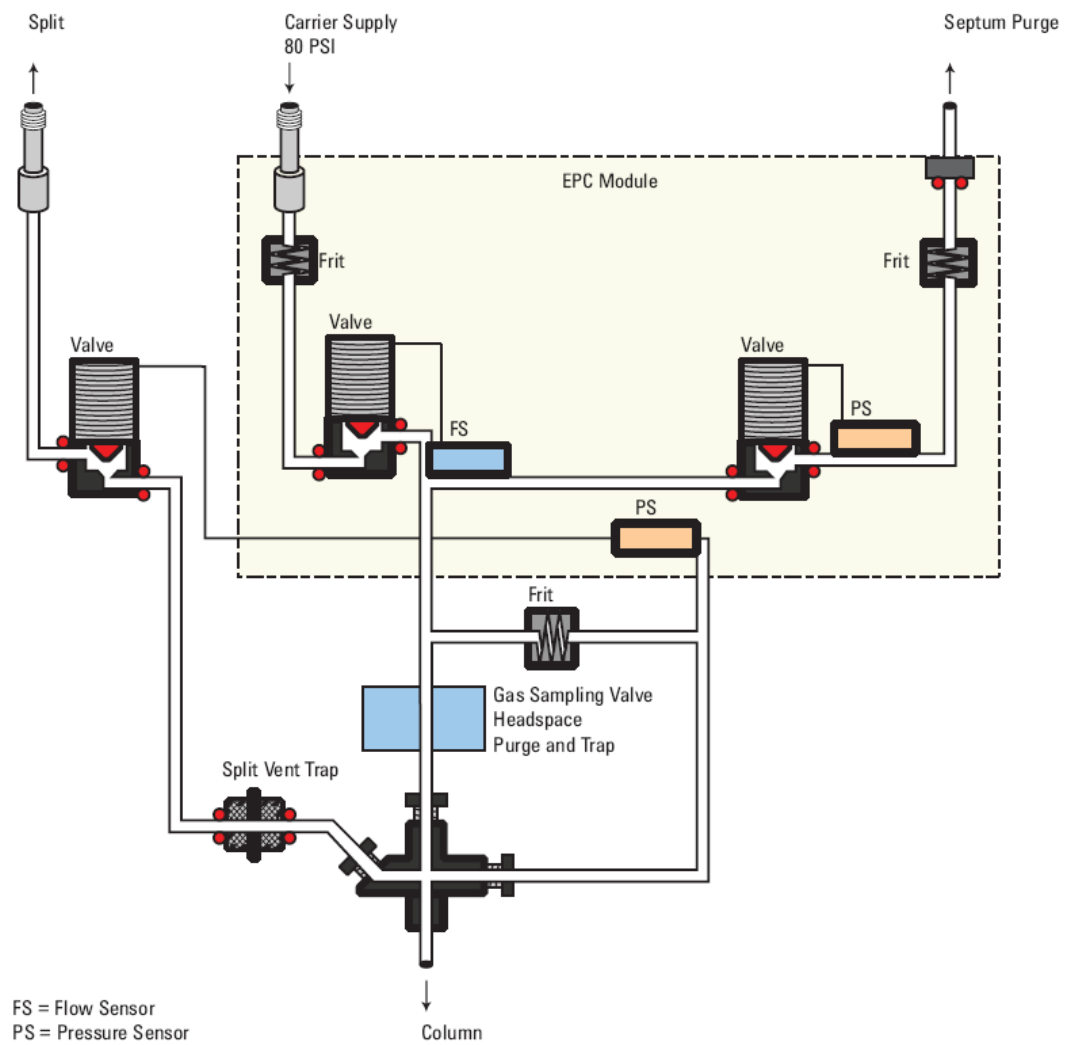

Volatiles Interface

Small internal volume (35 ul)

Inert surface (Silcosteel coated)

Helium and H₂ carrier only –
no N₂

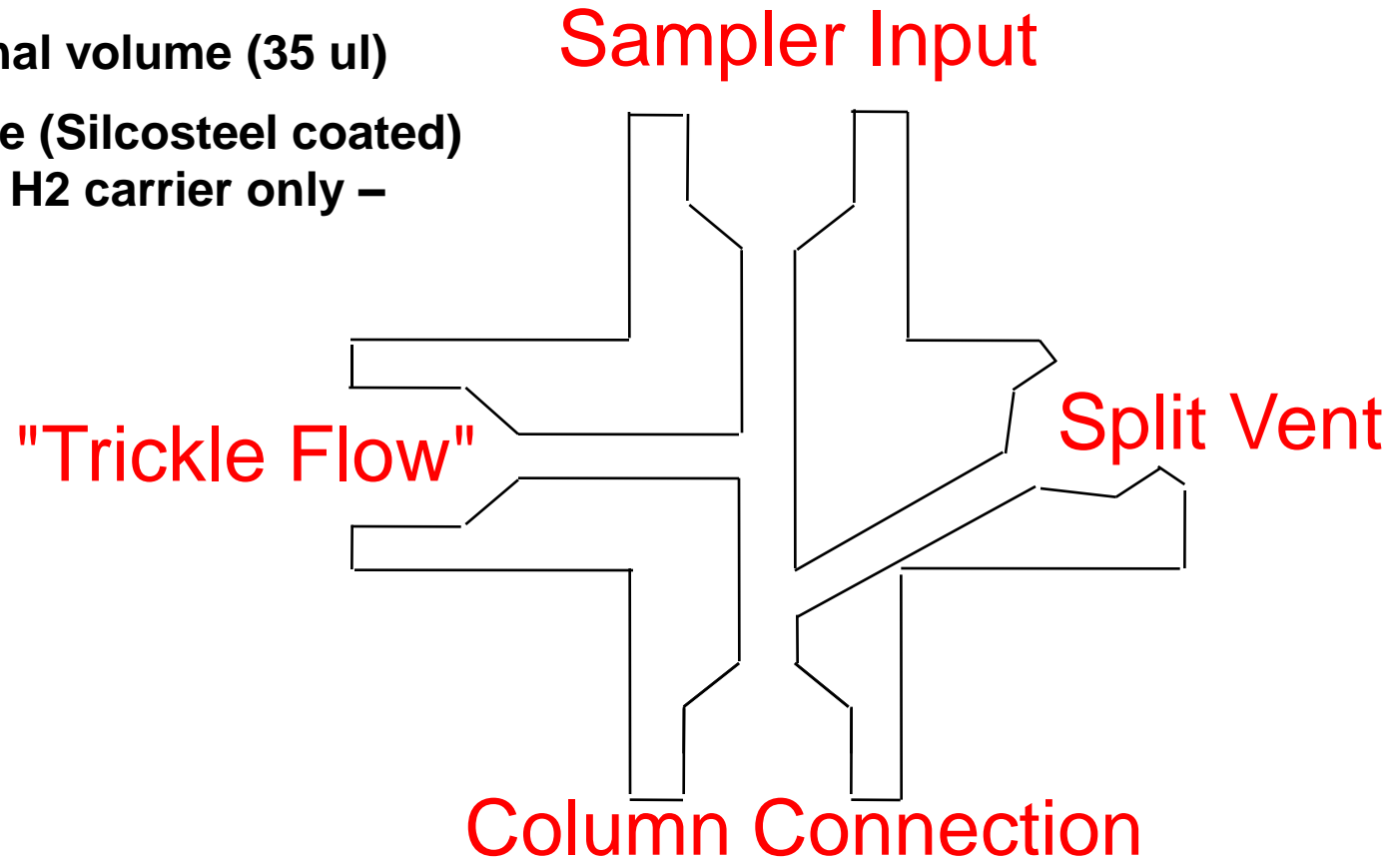

Volatiles Interface

Splitless Injection

Pre-Run to Sampling End

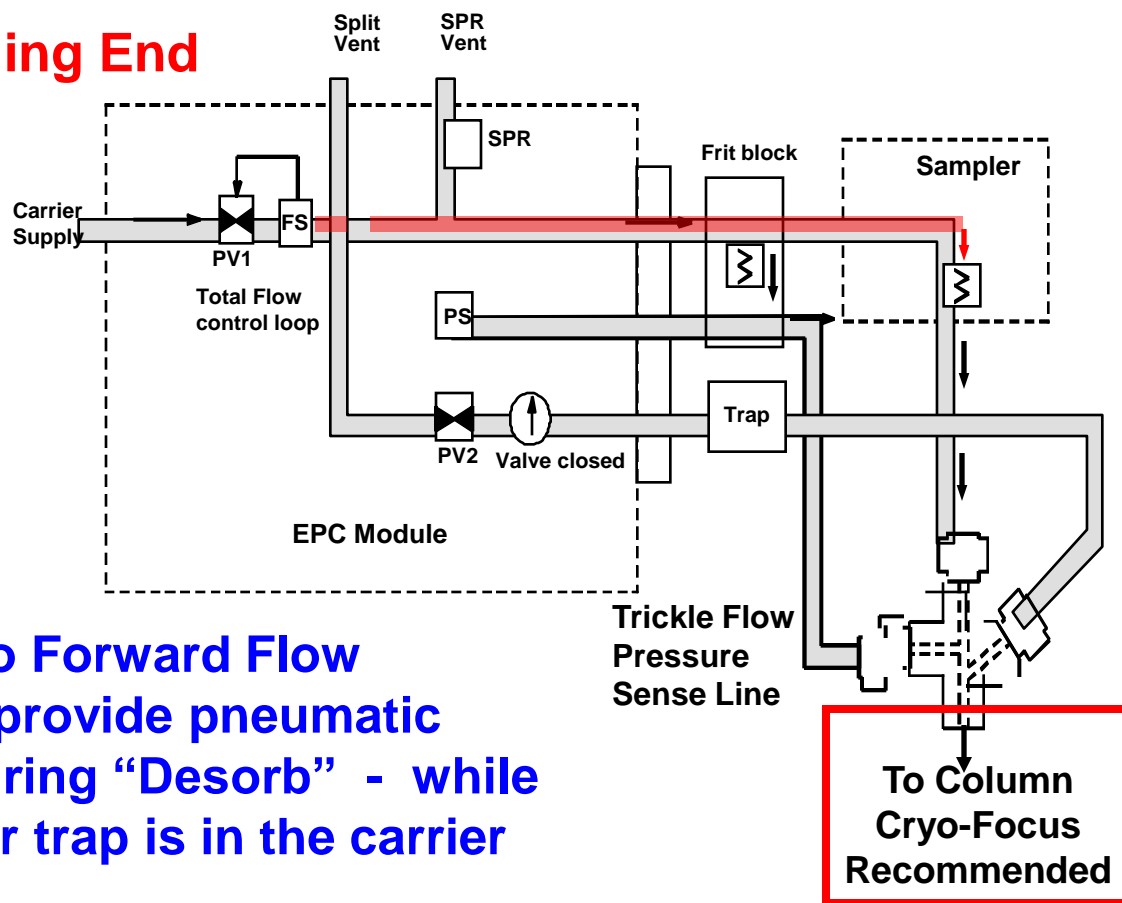

Switches to Forward Flow Control to provide pneumatic stability during “Desorb” - while the sampler trap is in the carrier flow path.

Volatiles Interface Modes of Operation

- Split
- Splitless
- Direct

Volatiles Interface -- Uses

- Used for direct connection between Headspace / Purge & Trap
- Cannot do Manual Injections!

Purged Packed Inlet

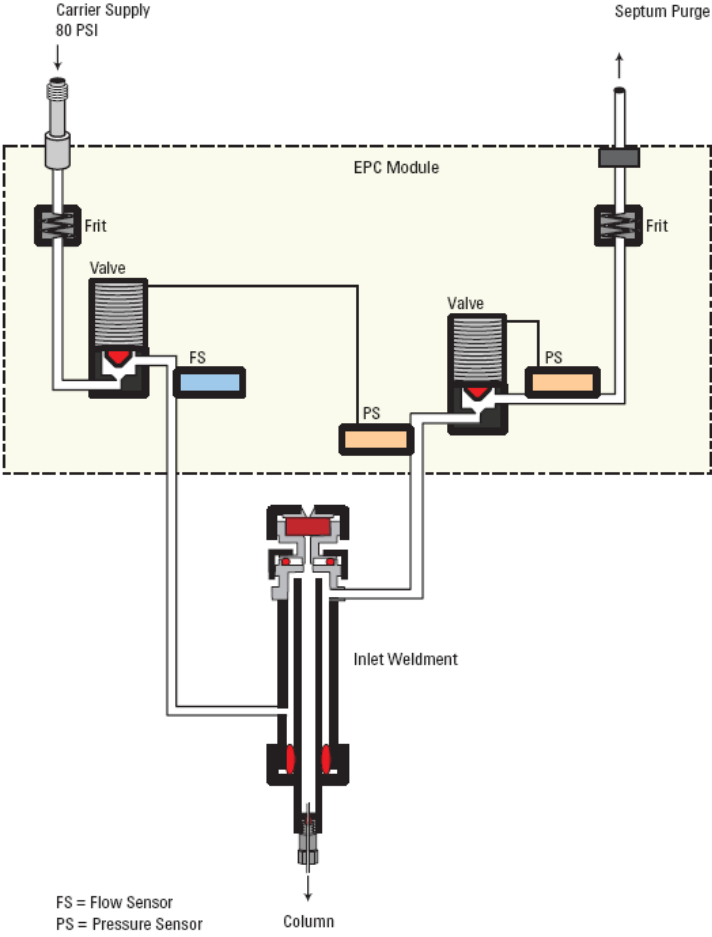

Purged Packed

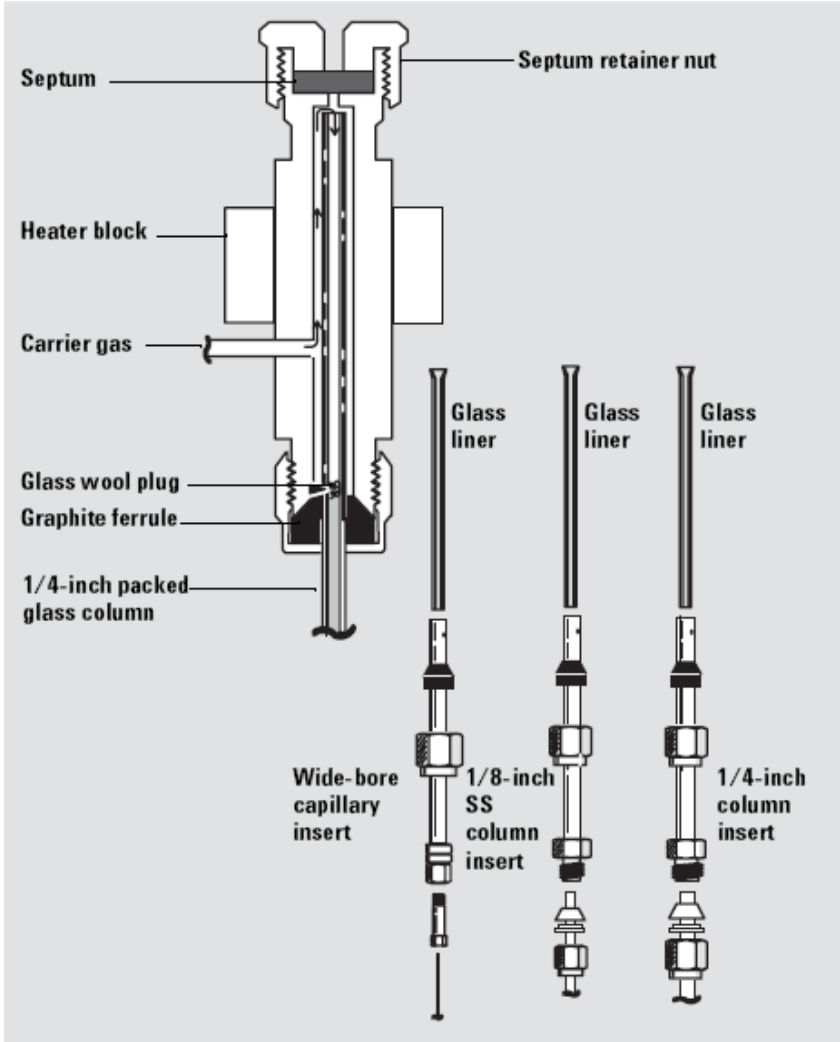

PP Inlet Uses

Packed columns

Can be used with 0.53 mm , or 0.32 mm ID columns when high flows ~10 mL/min are used

When column dimensions are not defined, the inlet functions in a 'flow' mode

Packed columns best run in flow mode, capillary columns preferred to run in pressure mode.

PP Inlet

Very small expansion volume

More active than most inlets

- Glass liner helps minimize activity

- Glass packed columns have best reproducibility

- Small surface area of the liner minimizes the amount of active sites

Not Recommended for Capillary Columns smaller than 0.53 mm

Split/Splitless Inlet

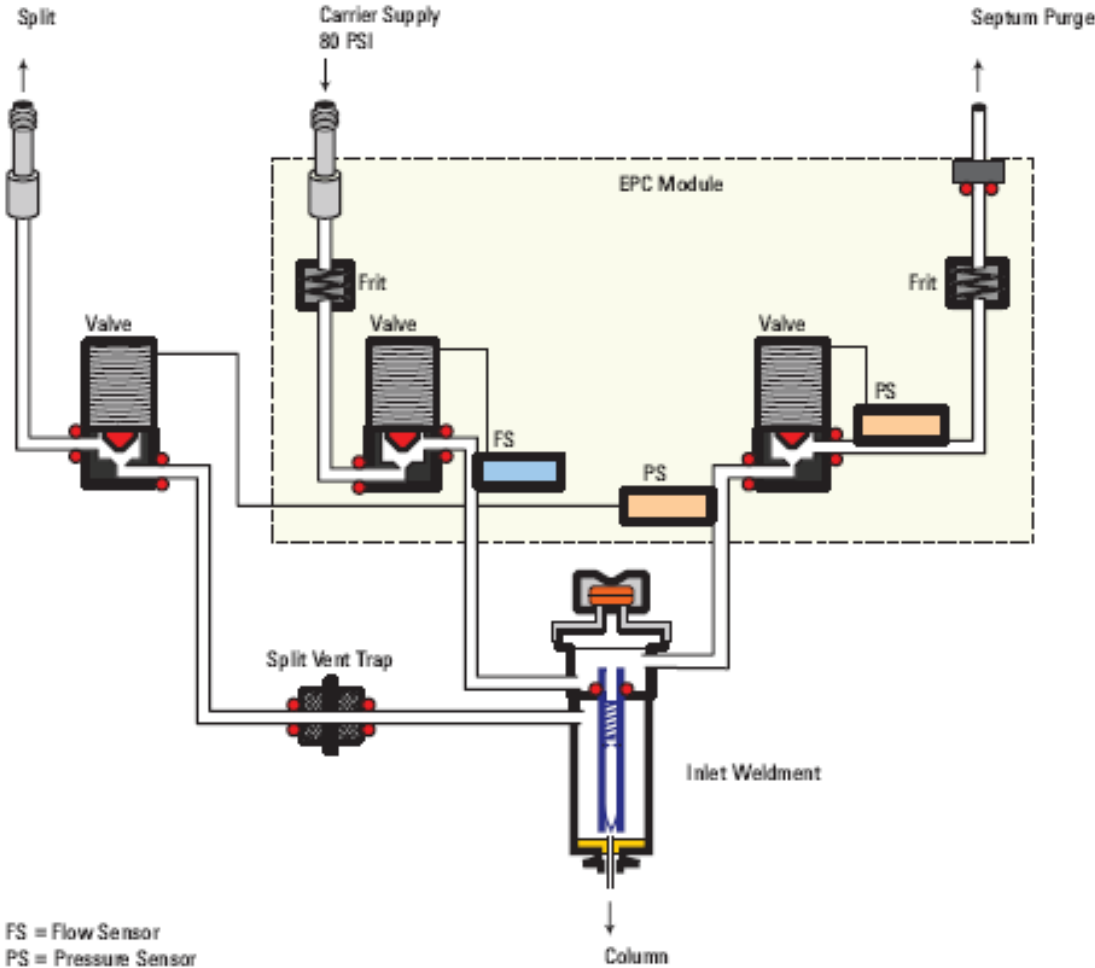

S/SL Modes of Operation

Split

Pulsed Split

Splitless

Pulsed Splitless

New Agilent Inert Flow Path Components for Active Compounds

Split Injections - Considerations

Dirty Samples are OK - backflushing

Wide Analyte Boiling Range

Solvent Properties

- Wide Boiling Point Range
- Wide Polarity Range

Discrimination can be due to liner or inlet temperature

Split Injections - Inertness

More inert than splitless

- Higher velocity through the inlet
- Less exposure to inlet hardware

Glass wool is a compromise

- Exhibits some activity
- Greatly improves fluidic performance – mixing of the vaporized sample is important for uniform splitting



Split Injections - recommended Liners

Agilent p/n 5190-2295

Ultra Inert Inlet Liner

Wiped needle improves

- precision
- peak shape
- discrimination

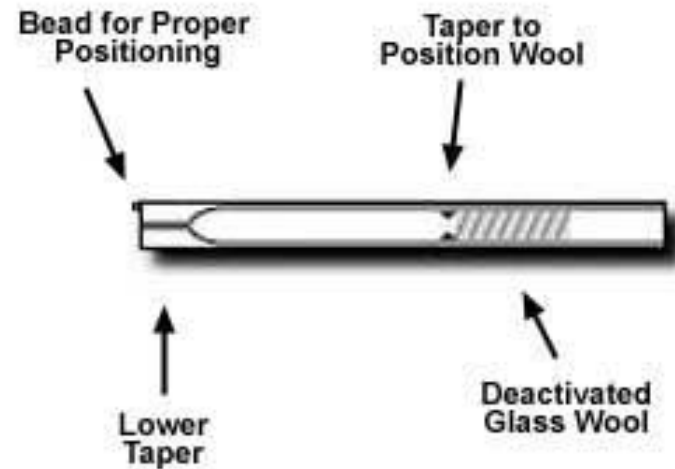

Split Injections - Maximizing Sensitivity

Increase Injection Volume

- liner dependent (use the Pressure-Volume Calculator)
- 2 μL maximum

Reduce Split Ratio

- go from 50:1 to 10:1
- 5:1 practical lower limit for liquid injections (for 250 - 320 μm i.d. columns)
- 1:1 possible for gas injections with correct liner

Use Pulsed Injection

Split Injector

Injection Volume

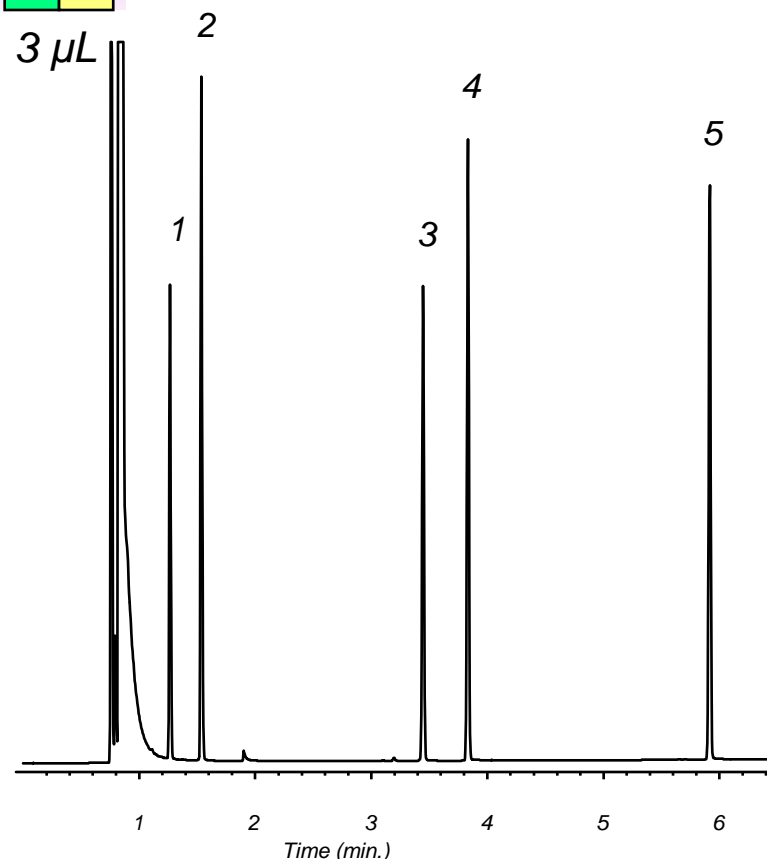
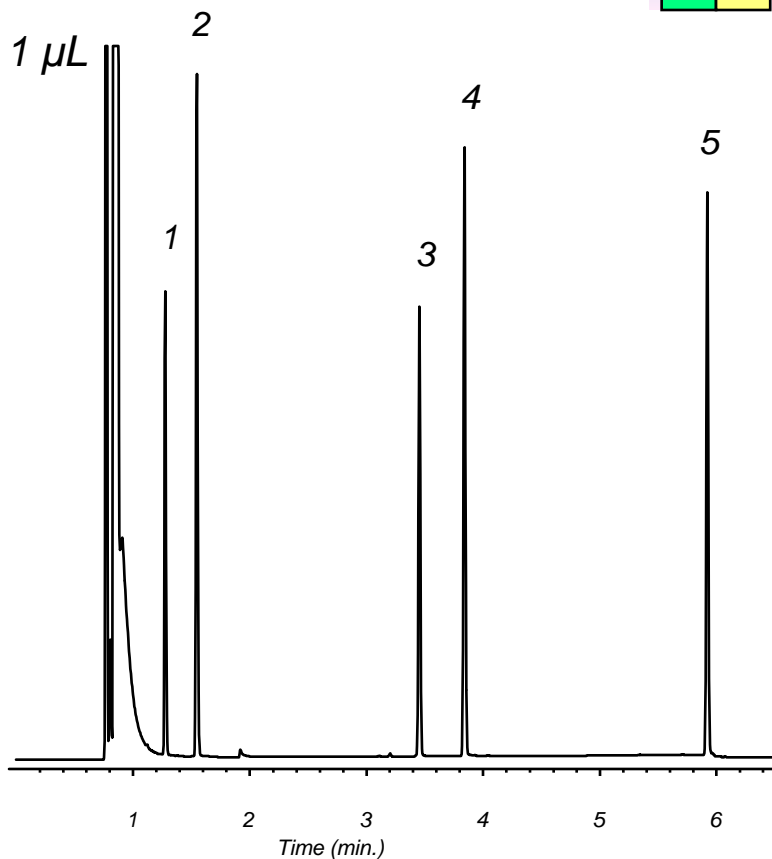
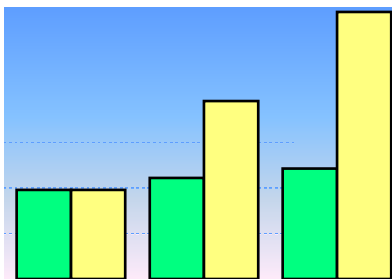

DB-1, 15 m x 0.25 mm I.D., 0.25 µm

60°C for 1 min, 60-180°C at 20°/min; Helium at 30 cm/sec

1. n-heptane 2. toluene 3. n-decane 4. n-butylbenzene 5. n-tridecane

Split Injections - Pulsed

May be easiest approach for active analytes
(example: 2,4 dinitrophenol)

Using “pulsed mode” may result in peak doublets due to system ramping down at 99 psi/min

Instead, use “ramped pressure” or “ramped flow” mode to do your pulse

- set initial pressure (or flow) to 3x-5x your normal starting set point
- hold this higher pressure for 0.1 - 0.3 min
- ramp at 20 psi/min (or 10 mL/min/min) down to your normal starting set point

Split Injections - Fast GC Considerations

Faster than splitless because you can start at a higher initial oven temp, thereby decreasing cycle time

Easiest of the injection techniques to speed up

For 100 μm i.d. and smaller columns

- narrower i.d. liners may be necessary to maintain input peak width

Using higher flows with normal columns

- Loose some resolution
- Better inertness
- Larger injections possible

Split Injections - Troubleshooting

Column pressures <10 psi

- The pressure pulse from evaporating solvent can cause discrimination and poor precision

Liner residence times < 0.5 sec (> 200 ml/min)

- poor mixing will cause discrimination

No glass wool

Solvents with high expansion ratio

Column position - top to bottom, side to side

Large bore, short columns with a high split ratio

Splitless Injections - Considerations

Dirty samples are OK - backflushing

Analyte Boiling Range - Wide (but narrower than split)

- early eluters need bp difference vs solvent

Solvent Properties

- Wide Boiling Point Range
 - but consider bp of earliest eluting analyte
- Wide Polarity Range (but narrower than split)
 - Water and Methanol worst choices

Greater Sample Residence Time

Lower Inlet Temperatures can be used

Better for Labile Compounds

Splitless Injections - Inertness

Less inert than COC

- liner and inlet interaction

Less inert than Split

- longer residence time in inlet and on glass wool
- used for trace analysis, so there's a greater chance of analyte loss

Consider Inert Flow Path Component Parts for improved Inertness!

Splitless Injections - Discrimination

Improper purge time

- short purge times cause loss of late eluters
- long purge times cause solvent tail interference with early eluters

Improper initial oven temp

- too high of a temp prevents solvent effect and a loss of early eluters
- too low of a temp extends run time

Splitless Injections – Splitless Time (purge time on)

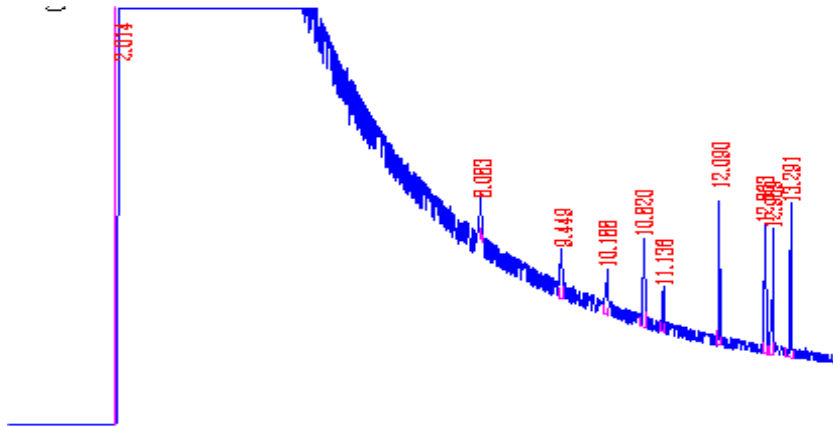

Purge time too long results in large solvent tail

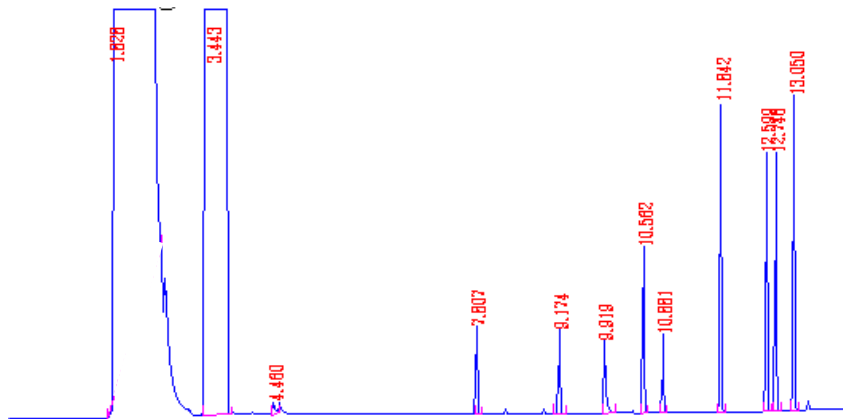

0.75 min purge time clips solvent tail

Splitless Injector

Injection Volume

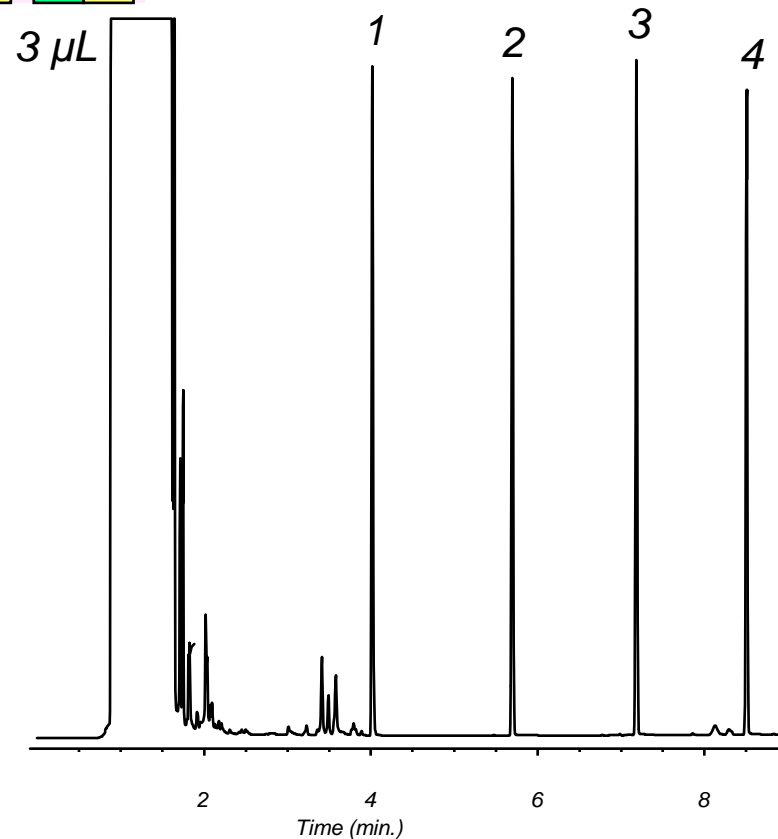
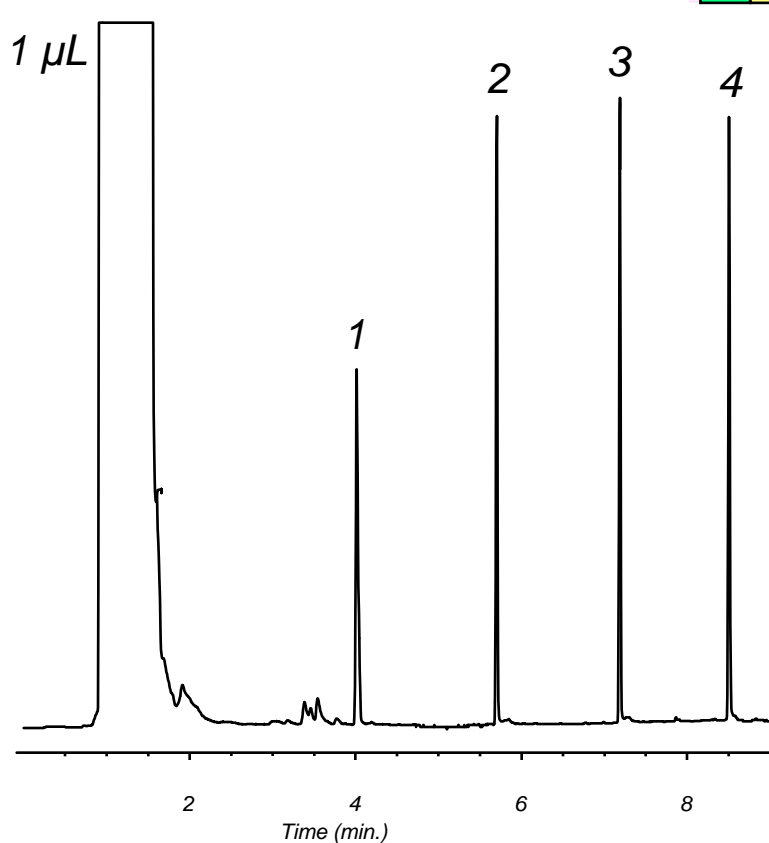
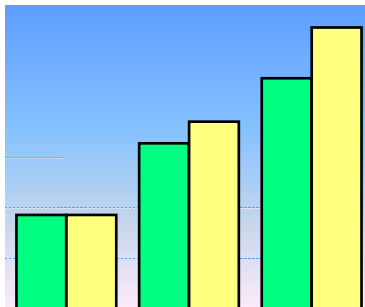

DB-1, 15 m x 0.25 mm I.D., 0.25 µm

60°C for 1 min, 60-180°C at 20°/min; Helium at 30 cm/sec

1. n-decane 2. n-dodecane 3. n-tetradecane 4. n-hexadecane

Splitless Injector

Injector Temperature

200°C

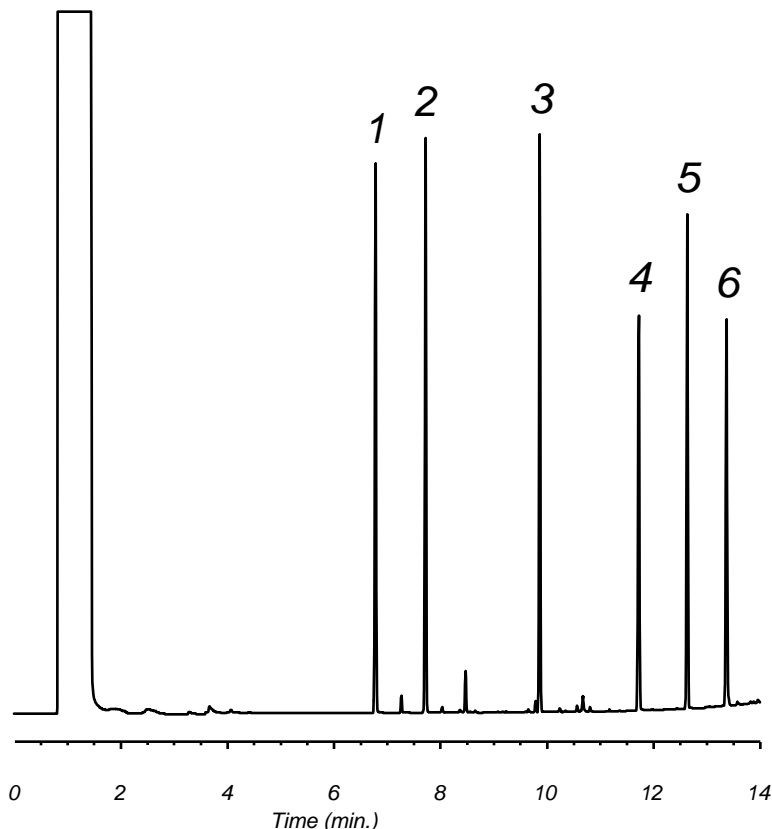

250°C

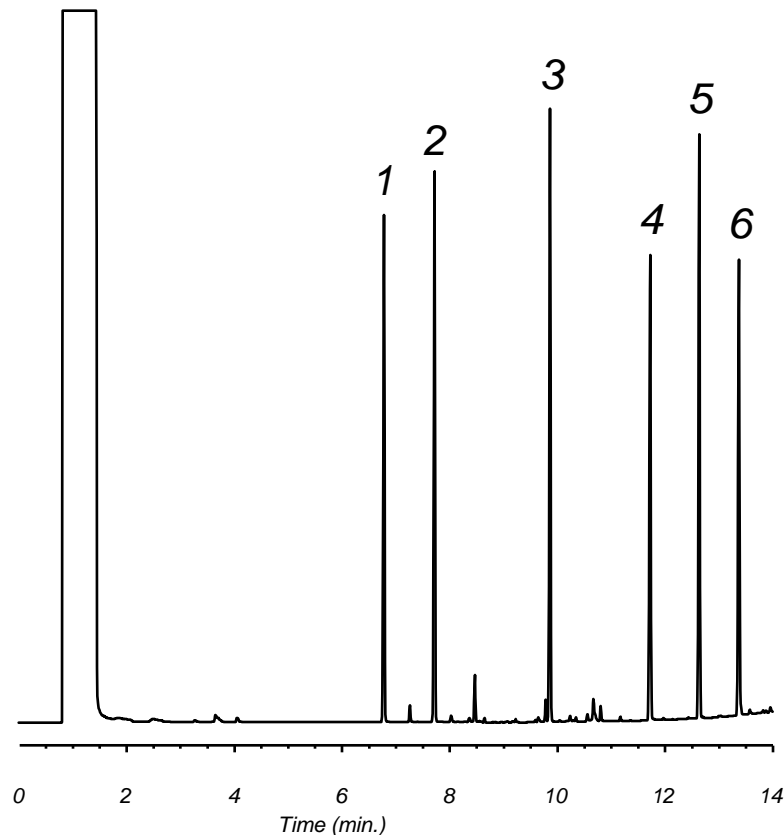

DB-1, 15 m x 0.25 mm I.D., 0.25 μ m

50°C for 0.5 min, 50-325°C at 20°/min; Helium at 30 cm/sec

Phthalates: 1. dimethyl 2. diethyl 3. dibutyl 4. benzylbutyl 5. bis(2-ethylhexyl) 6. dioctyl

Splitless Injector

Sample Re-focusing

Sample re-focusing improves efficiency

Use low column temperature to refocus solvent
- called the *solvent effect*

Use cold trapping



Splitless Injector

Solvent Effect

Initial column temperature at least **10°C below** sample solvent boiling point

Required to obtain good peak shapes unless cold trapping occurs

Rule of thumb, if solute BP >150°C above initial column temperature, the solute will cold trap

Cold trapping has greater efficiency than solvent effect

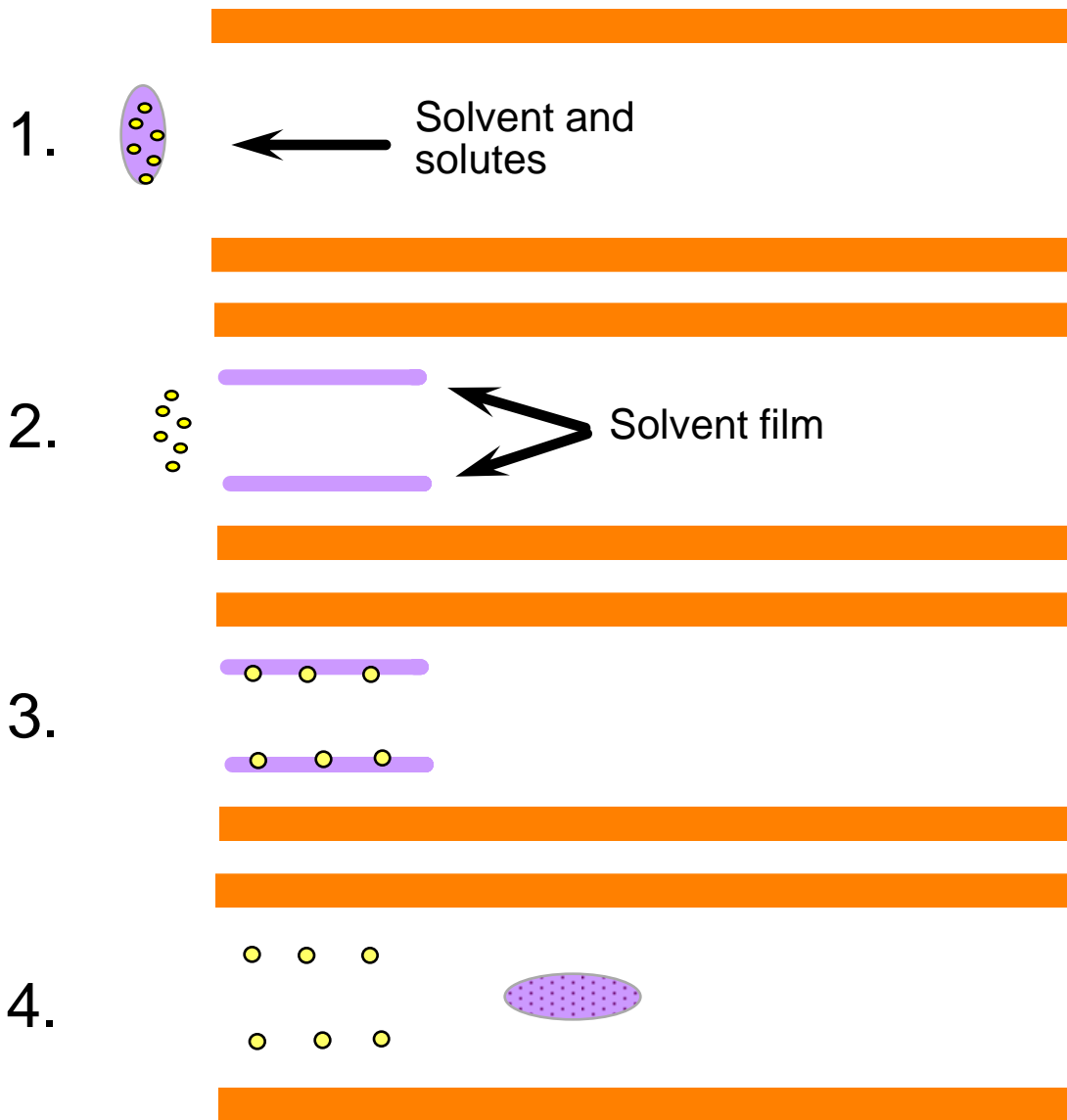

Splitless Injector

Initial Column Temperature

Hexane Solvent (BP = 68-69°C)

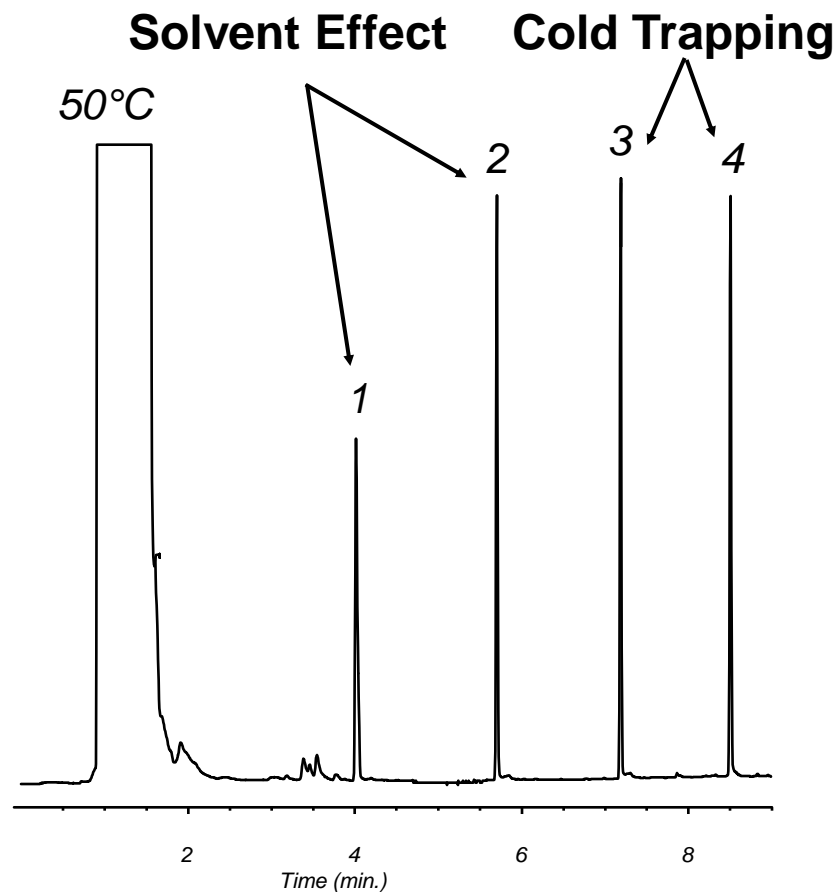
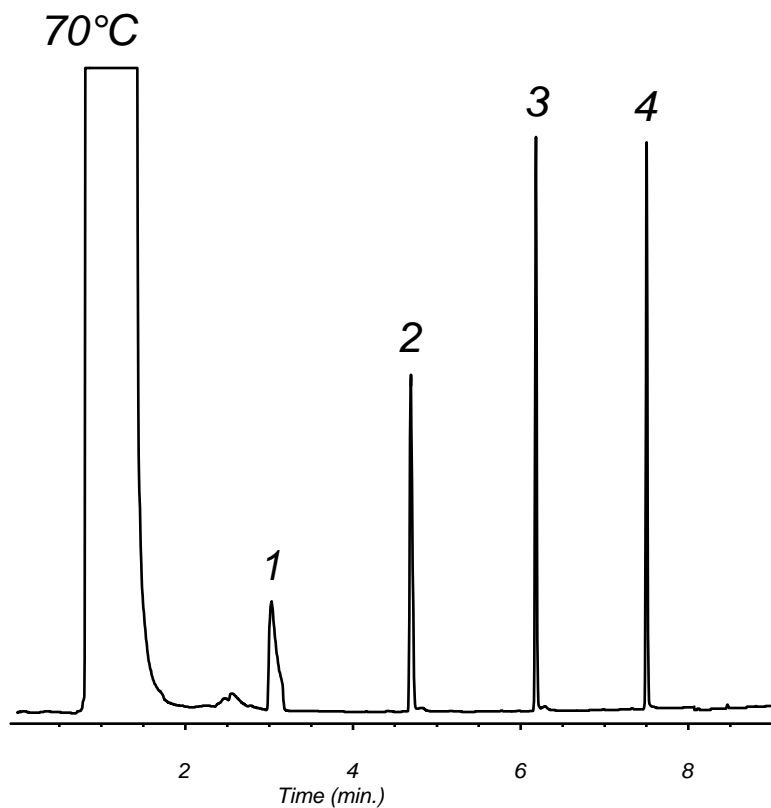

DB-1, 15 m x 0.25 mm I.D., 0.25 μ m

50°C or 70°C for 0.5 min, to 210°C at 20°/min; Helium at 30 cm/sec

1. n-decane 2. n-dodecane 3. n-tetradecane 4. n-hexadecane



Splitless Injector

Reverse Solvent Effect/Polarity Miss-Match

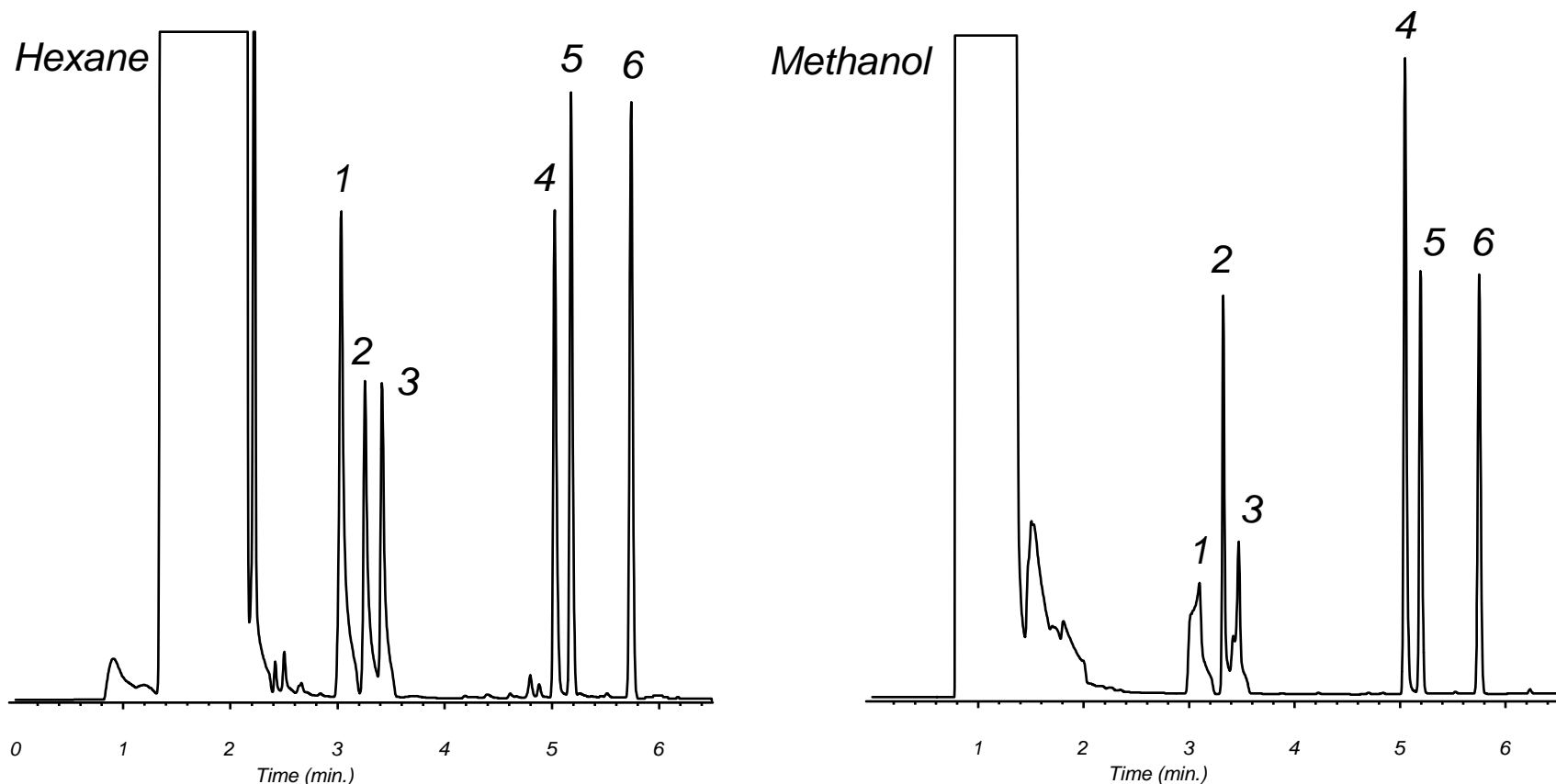

DB-1, 15 m x 0.25 mm I.D., 0.25 μ m

50°C for 1 min, 50-210°C at 20°/min; Helium at 30 cm/sec

1. 1,3-DCP 2. 3-hexanol 3. butyl acetate 4. 1-heptanol 5. 3-octanone 6. 1,2-dichlorobenzene

Retention Gap

Also Called A Guard Column

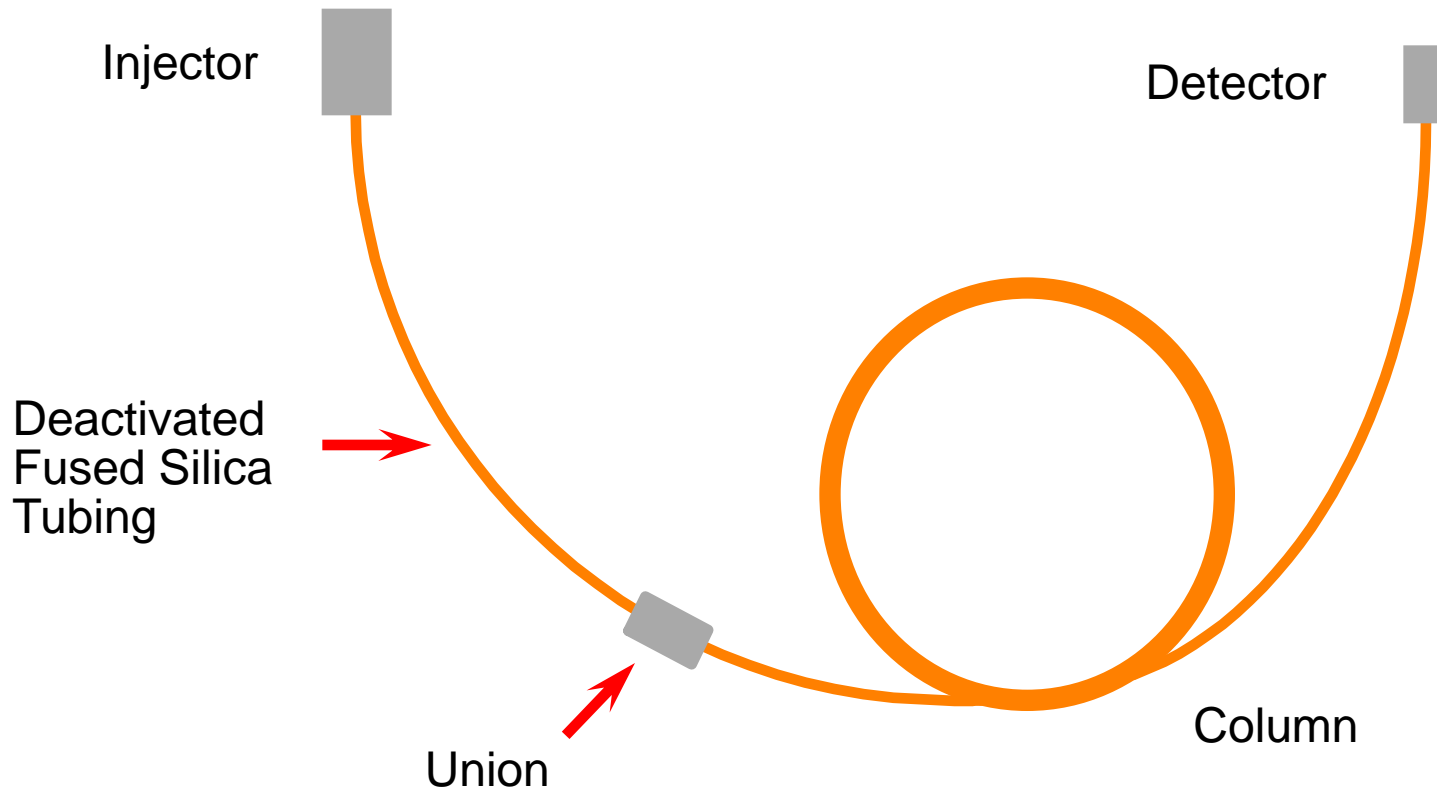

Usually 2-10 meters long and same diameter as the column
(or larger if needed)

Splitless Injector

3 m x 0.25 mm I.D. Retention Gap

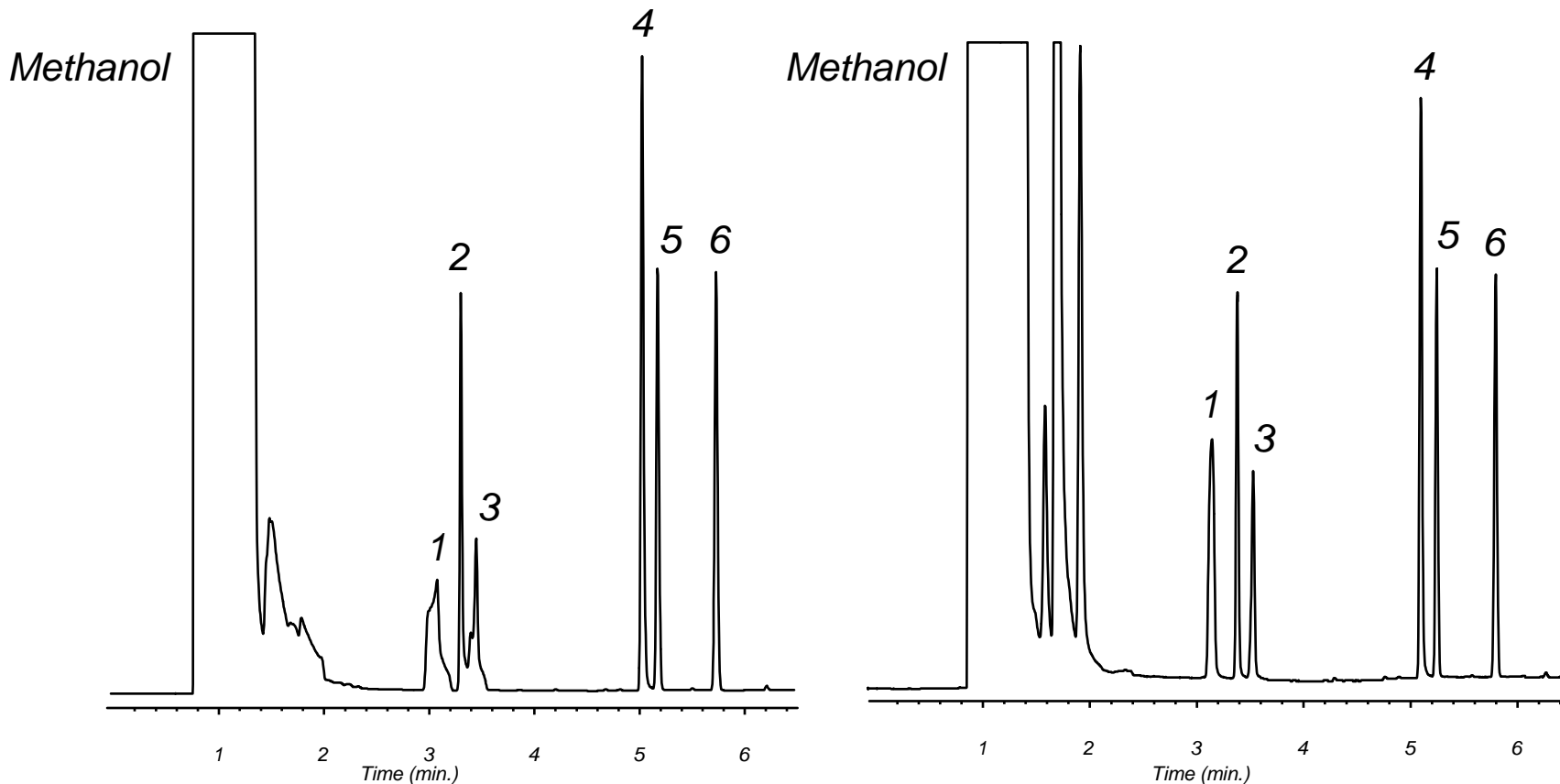

DB-1, 15 m x 0.25 mm I.D., 0.25 μ m

50°C for 1 min, 50-210°C at 20°/min; Helium at 30 cm/sec

1. 1,3-DCP 2. 3-hexanol 3. butyl acetate 4. 1-heptanol 5. 3-octanone 6. 1,2-dichlorobenzene

EPC for Splitless Pulsed Injection

Pressure Pulse contains sample expansion and transfers analytes to the column faster.

Pulsed Splitless

- sample containment more critical than in split injection
- sharper peaks than in traditional splitless injection
- two new parameters to set:
 - pulse pressure and pulse time

Typical starting point

- Pulse pressure = double resting pressure
- Tie pulse time to purge time

Splitless Injections – Fast GC Considerations

Slower than split because you must start at a lower initial oven temp, thereby increasing cycle time

Difficult to use with 100 μm i.d. columns

- smaller injection size
- smaller liner volume
- retention gap

Using higher flows with normal columns

- Lose some resolution
- Better inertness
- Larger injections possible

Splitless Injections – Starting

Injection Volume = 1 μ L

- Check the Pressure-Volume Calculator

Initial Oven Temp = 10°C < solvent boiling point

Purge Flow = 20 to 60 mL/min

Purge Time = 0.75 min

- Sweep with 2 liner volumes of carrier gas

No pulse

Try to avoid water and methanol as solvents

Splitless Injections – Troubleshooting Tips

Injecting too much

- column overload = poor peak shape
- inlet overload = poor reproducibility
 - ghost peaks in subsequent blanks are possible

No glass wool

- poor mixing
- dirt on column

Glass wool

- Can react with trace components
- Use Agilent Ultra Inert Liners to improve performance

Splitless Injections – Troubleshooting Tips

If you think you have an inlet issue related to splitless injections

- then

Run a 10:1 split injection

- or

Make up a standard at 10x concentration and run a 10:1 split injection

When I changed from split to splitless I didn't see an increase in response!!!

Purge Time set to '0'

Split Vent Trap

What is it??? P/N 5188-6495



Split vs. Splitless Injection Technique - Summary

SPLIT:

- Best Injection Efficiency
- Less sensitive
- Prone to discrimination
- Proper liner choice more important

SPLITLESS:

- Poor Injection efficiency
 - solvent effect
 - retention gap
- Good for Trace level detection
- Solvent/column polarity match more critical

but...what if you are already running maximum injection volume, pulsed splitless and still need more sensitivity...

MultiMode Inlet

7890 standard
pneumatics

7890 standard
capillary fitting



7890 turn-top

Uses 7890 S/SL
liners, septa and
o-rings

MMI Inlet

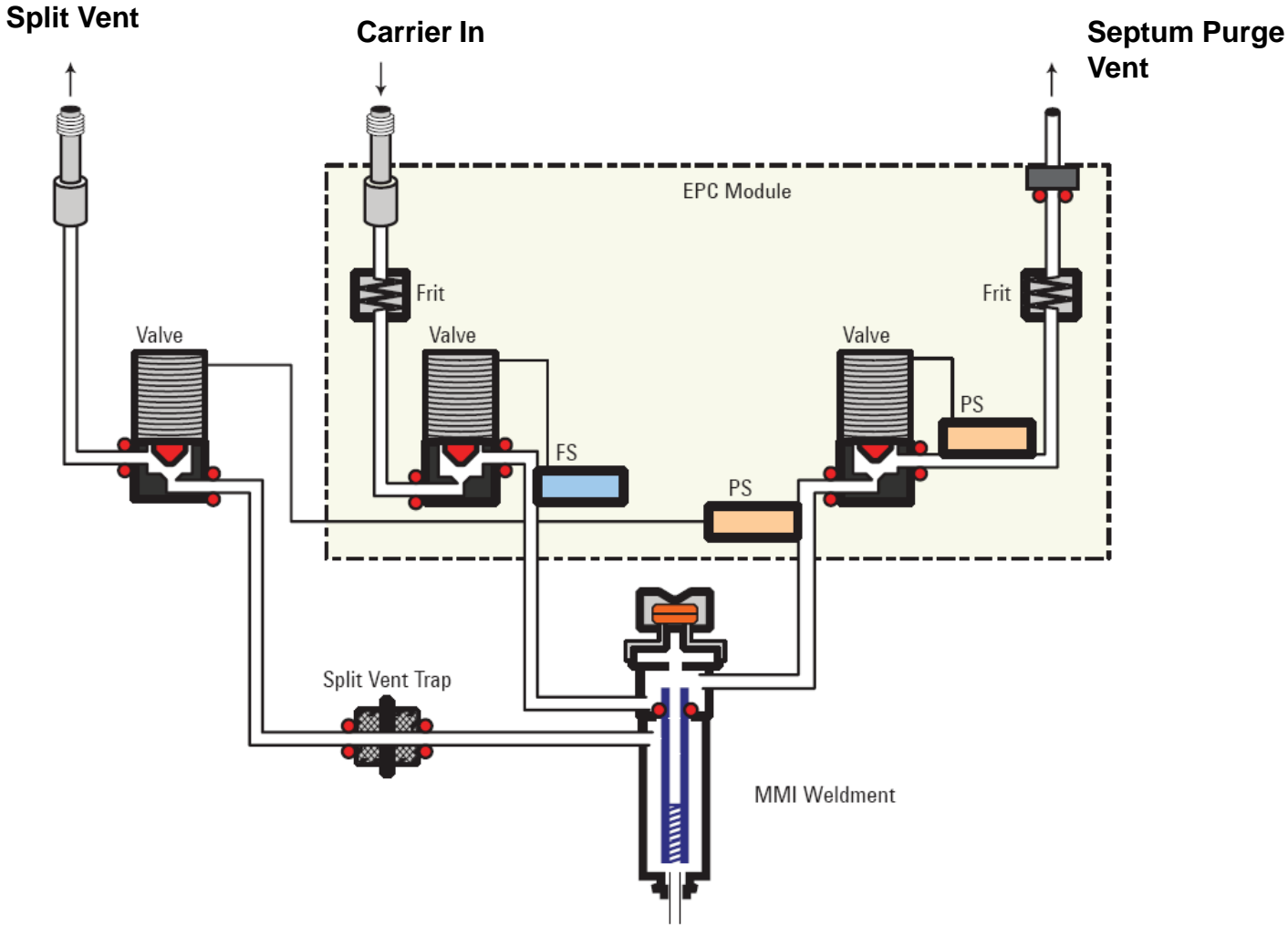

Programmable Temperature Vaporizing (MMI) Inlet – injection modes

Hot split/splitless (also pulsed)



- similar to the S/SL inlet using the **same liners**
- all previous S/SL discussions apply here

Cold split/splitless (also pulsed)

- Significantly more inert than hot splitless
- Can inject 3-5 uL with no solvent venting
- Better sensitivity than hot splitless because large vapor cloud is not formed which travels outside the liner and portions are lost

LVI-Solvent Vent

- An extension of cold splitless
- Large volume injection for maximum sensitivity

Direct Mode

Uses a Direct Connect Liner – simulates COC * NO purge

MultiMode (MMI) Inlet Features

Hardware

Temperature range of -160C to 450C

Heating @ 15C/sec (900C/min)

Septum/Liner Easily Exchangeable using Turn Top Inlet

Injection Modes: Hot S/SL, Cold S/SL, all in pulsed mode, solvent vent mode, residue removal mode

Support for single stroke injections from 0.1 μ L to 250 μ L

EPC Compatible with Packed Liners

Compatible with 7890A, 5975C, 7683, CTC Combi PAL

Software

Ten temperature ramps

Wizard for setting up large volume injections

Fully integrated into ChemStation, MSD ChemStation, EZChrom, MassHunter

Multimode Inlet Solves Many Problems

Performing large volume injection (LVI) of relatively clean samples?

- programmable injection slows solvent evaporation and maximizes analyte transfer into the column/detector
- decrease MDL by injecting more sample

Injecting dirty samples?

- matrix vent, backflush and easy liner changing minimize dirty sample affects

Performing analyses of high molec. wt. and/or thermally labile compounds?

- temperature programming of Multimode inlet elutes analytes at the lowest possible temperature, minimizing breakdown and absorption
- discrimination of high molec. wt. compounds is minimal allowing HT GC

Multiple Mode GC Inlet - Cold Injections

- No syringe-needle discrimination; Minimal inlet discrimination
- No special syringes, liners or consumables
- Large volume injection (5ul to 250ul) - lower detection limits
- Solvent vent/matrix vent - decrease interference / maintenance
- Flexibility (hot/cold split/splitless, temperature programmed vaporization)
- Cold trapping in liner - improves chromatographic peak shape, resolution
- Capillary column backflush with CFT - decreases cycle time, maintenance



MMI Column Installation

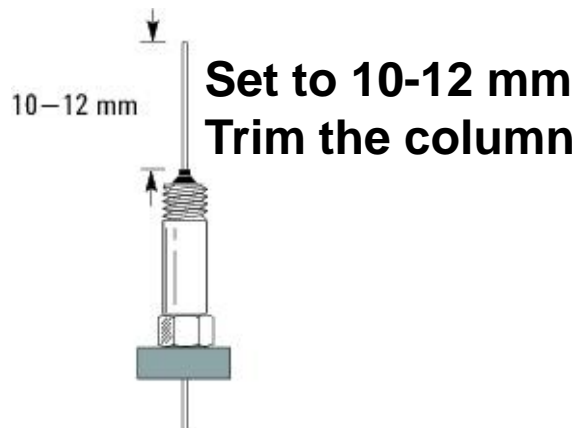
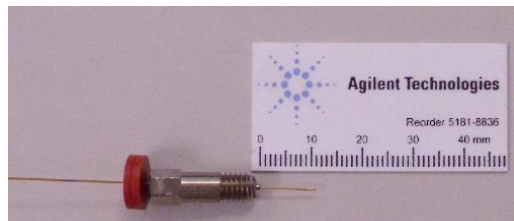

- Graphite ferrules are recommended over Vespel
- No SiTite Ferrules



Thread the column into the column adapter – Stabilize the column adapter with a 5/16” wrench



Tighten the column with a 1/4” wrench – continue to hold the column adapter with a 5/16” wrench

Conclusions

Try to understand the sample as much as you can.

Residues, concentrations, solvent expansion

Packed columns are used with a PP inlet only

MMI or PTV for large volume injections (trace analysis)

MMI, PTV or COC for Labile compounds, or high bp compounds

SSL inlet is the most common

MMI is a combination of the SSL and PTV gives more flexibility

does have issues with cleaning

Inlet Column Installation Guide

Inlet	Diagram	Procedure
Split/Splitless		<p>Place a septum over the column, then the column nut and ferrule. Trim the end of the column with a column cutter.</p> <p>Pull the column back so that 4-6 mm of column is extending past the end of the ferrule.</p> <p>Thread the column nut and column into the inlet and tighten slightly past where the column grabs – retighten after heating.</p>
Purged Packed		<p>Place a septum over the column, then the column nut and ferrule. Trim the end of the column with a column cutter.</p> <p>Pull the column back so that 1-2 mm of column is extending past the end of the ferrule.</p> <p>Thread the column nut and column into the inlet and tighten slightly past where the column grabs – retighten after heating.</p>
Multimode		<p>NOTE: Make sure the column adapter nut on the inlet base is <i>fully threaded on and spinning freely - Collar Up!</i></p> <p>Tighten with two wrenches - 3/4" and 5/16" To prevent damage the inlet threads.</p>
Cool On Column		<p>Insert the column all the way into the inlet until you feel the spring tension – do not withdraw.</p> <p><i>The column cut is critical.</i></p> <p>Tighten with two wrenches - 3/4" and 5/16" to avoid damaging the inlet.</p>
PTV		<p>There should be 17mm of column above the graphpak ferrule – the graphpak ferrule should be installed with the graphite end towards the inlet base. The column nut is slotted. Use a 5 mm wrench to tighten the fitting.</p>
Volatiles Interface		<p>There is a longer column nut for the VI so that you don't have to remove the inlet block.</p> <p>Part Number - G3504-20504</p>

Agilent/J&W Technical Support

800-227-9770 (phone: US & Canada)*

•*Select option 3, then option 3, then option 1.*

•**866-422-5571 (fax)**

GC-COLUMN-Support@Agilent.com

